

Printable Help Document



TDSJIT3 v2

Jitter Analysis Application

077-0023-00

This document supports software version 3.0.0 and above.

www.tektronix.com

Copyright © Tektronix, Inc. All rights reserved. Licensed software products are owned by Tektronix or its suppliers and are protected by United States copyright laws and international treaty provisions.

Tektronix products are covered by U.S. and foreign patents, issued and pending. Information in this publication supercedes that in all previously published material. Specifications and price change privileges reserved.

TEKTRONIX and TEK are registered trademarks of Tektronix, Inc.

TDSJIT3v2 Jitter Analysis Application Online Help, 077-0023-00, Version 3.0.0

Contacting Tektronix

Tektronix, Inc.

14200 SW Karl Braun Drive or P.O. Box 500

Beaverton, OR 97077 USA

For product information, sales, service, and technical support:

- In North America, call 1-800-833-9200.
- Worldwide, visit www.tektronix.com to find contacts in your area.

Table of Contents

General Safety Summary	xiii
Preface	xv
5-Time Free Trial.....	xv
Related Documentation.....	xv
GPIB Information	xv
Relevant Web Sites.....	xvi
Application CD Contents.....	xvi
Conventions	xvii
Types of Online Help Information.....	xvii
Using Online Help	xviii
Find Tab and Searches.....	xviii
Feedback.....	xix
Getting Started.....	1
Differences between TDSJIT3 v2 Advanced and TDSJIT3 v2 Essentials	1
Compatibility	2
Requirements and Restrictions	2
Accessories	2
Installation	2
Connecting to a Device Under Test (DUT)	2
Deskewing Probes and Channels.....	3
Operating Basics	5
General Information.....	5
Starting the TDSJIT3 v2 Application	5
Returning to the Application	6
Minimizing and Maximizing the Application.....	6
Exiting the Application.....	7
Application Directories and Usage	7
Tips on the TDSJIT3 v2 User Interface.....	8
How to Enter Numeric Values.....	9
Virtual Keypad	9
Using Basic Oscilloscope Functions.....	10
File Menus	10
Navigating the User Interface	10
General Steps to Set Up the Application	11
Jitter Wizard	11
User Interface Information	13
Setting Up the Application for Analysis	15
Selecting Measurements	15
Configuring a Measurement	19
Configuring Sources	37
Measurement Summaries	49
Taking Measurements.....	49
Localizing Measurements.....	50
About Sequencing.....	50
Acquiring Data	50
New Acquisition Function of the Single Button.....	51
Control Panel Functions	51

Clearing Results.....	52
Results as Statistics.....	53
Viewing Equivalent Rj/Dj Results (TDSJIT3 v2 Advanced Only).....	53
Results as Plots.....	54
Using a Separate Monitor to View Plots.....	55
Plot Usage.....	55
Creating Plots.....	57
Configuring Plots.....	58
Working with Plots.....	64
Toolbar Functions in Plot Windows.....	64
Selecting and Viewing a Plot.....	65
Moving and Resizing a Plot.....	65
Deleting Plots.....	66
Using Zoom in a Plot.....	66
Using Cursors in a Plot.....	67
Exporting Plot Files.....	71
Saving Information to Log Files.....	73
Logging Statistics.....	74
Logging Measurements.....	75
Logging Worst Case Waveforms.....	77
File Names for Logging Worst Case Waveforms.....	77
Saving and Recalling Setup Files.....	78
Saving a Setup File.....	78
Recalling a Saved Setup File.....	80
Recalling the Default Setup.....	81
Recalling a Recently Saved or Accessed Setup File.....	81
Recall Recent Files Example.....	81
Recalling a Setup File from a Earlier Version of Software.....	81
Docking and Undocking the Jitter Analysis Window.....	82
Acquisition Timeout Utility.....	82
Warnings Utility.....	83
Tutorial.....	85
Setting Up the Oscilloscope.....	85
Starting the Application.....	85
Waveform Files.....	85
Recalling a Waveform File.....	86
Taking a Clock Period Measurement.....	87
Setting Up a Period Measurement.....	87
Taking a Period Measurement and Viewing Statistical Results.....	89
Viewing a Period Measurement as Plots.....	90
Ending a Tutorial Lesson.....	92
Taking a Clock-to-Output Time Measurement.....	92
Setting Up and Taking a Clock-to-Output Time Measurement.....	92
Logging Statistics to a .CSV File.....	95
Logging Data Points as a Measurement Snapshot to a .CSV File.....	98
Logging Worst Case Waveforms to .WFM Files.....	100
Lessons Learned.....	102
Application Examples.....	105
Recall Default Settings.....	105
Recall a Waveform and Start the Application.....	105
Application Example 1: Spectral Analysis.....	106
Set Up and Take Measurements for Example 1.....	106
Approximate Pattern Length Measured with Cursors.....	107

Measuring Rj/Dj and Tj @ BER.....	108
Using Spectral Analysis to Find Jitter Sources.....	109
Application Example 2: Trend Analysis.....	111
Set Up and Take Measurements for Example 2.....	111
Using Trend Analysis to Find Jitter Amplitude and Anomalies.....	112
Algorithms	115
Oscilloscope Setup Guidelines	115
Test Methodology.....	115
Timing Measurements	116
Rj/Dj Measurement (TDSJIT3 v2 Advanced Only)	116
Spectrum Analysis Based Rj/Dj Separation	116
Arbitrary Pattern Analysis Based Rj/Dj Separation.....	117
BER and Tj Estimation (TDSJIT3 v2 Advanced Only)	118
Effective Rj and Tj Estimation (TDSJIT3 v2 Advanced only).....	118
Single Waveform Measurements.....	119
Clock Period Measurement.....	119
Clock Frequency Measurement	119
Clock TIE Measurement.....	120
Clock PLL TIE Measurement (TDSJIT3 v2 Advanced Only)	120
Data Frequency Measurement	121
Data TIE Measurement.....	121
Data PLL TIE Measurement (TDSJIT3 v2 Advanced Only)	121
Cycle-to-Cycle Measurement	122
N-Cycle Measurement.....	122
Positive and Negative Cycle-to-Cycle Duty Measurements.....	122
Positive and Negative Duty Cycle Measurements.....	123
Rise Time Measurement.....	123
Fall Time Measurement.....	123
Positive and Negative Width Measurements	124
High Time Measurement	124
Low Time Measurement.....	124
Dual Waveform Measurements	125
Setup Time Measurement.....	125
Hold Time Measurement	125
Clock-to-Output Measurement	126
Clock-Data-TIE Measurement.....	126
Skew Measurement.....	126
Crossover Voltage Measurement (TDSJIT3 v2 Advanced Only)	127
Statistics.....	127
Maximum Value.....	127
Minimum Value.....	127
Mean Value	127
Standard Deviation Value.....	127
Maximum Positive and Maximum Negative Difference Values	128
Peak-to-Peak Value	128
Population Value	128
Parameters	129
File Menus Parameters.....	129
Control Panel Parameters.....	130
Measurements Select	130
Configure Measurements.....	131
Clock Recovery Parameters.....	132
Advanced Clock Recovery Parameters.....	133

Filters Parameters	133
Advanced Filter Parameters.....	133
TIE: RjDj Analysis Parameters (TDSJIT3 v2 Advanced Only).....	134
Configure Sources	134
Summaries	136
Results	136
Plots	136
Logs	138
Utilities	140
Help	141
GPIB	143
Program Example	144
GPIB Reference Materials.....	144
Starting and Setting Up the Application Using GPIB.....	144
Variable:Value Command	145
Measurements Results Queries.....	151
Index	157

List of Figures

Figure 1: Contents of the application CD-ROM.....	xvi
Figure 2: Deskew complete example.....	4
Figure 3: Deskew Summary example.....	4
Figure 4: Starting the TDSJIT3 v2 application.....	6
Figure 5: Returning to the application.....	6
Figure 6: Directory structure.....	8
Figure 7: On-screen keypad.....	9
Figure 8: General steps to set up the application.....	11
Figure 9: Jitter Wizard when launched.....	12
Figure 10: Menu with user interface items.....	14
Figure 11: Menu navigation tree.....	14
Figure 12: Measurements Select menu.....	16
Figure 13: Select Source options by measurement category.....	16
Figure 14: Clock edge options.....	21
Figure 15: Active edge options.....	21
Figure 16: Clock and Data edge options.....	22
Figure 17: From Edge and To Edge options.....	22
Figure 18: Main edge options.....	23
Figure 19: Meas Range Limits options.....	23
Figure 20: N-Cycle measurement options.....	24
Figure 21: Clock-Data-TIE measurement configuration.....	25
Figure 22: Bathtub Curve and BER versus Decision Time.....	27
Figure 23: TIE: RjDj analysis options for Clock TIE and Clock PLL TIE.....	28
Figure 24: TIE: RjDj analysis options for Data TIE and Data PLL TIE.....	28
Figure 25: Constant Clock Recovery concept.....	29
Figure 26: Reference Clock Frequency options.....	30
Figure 27: Phase-Locked Loop (PLL) Clock Recovery concept.....	30
Figure 28: PLL Loop Bandwidth options.....	31
Figure 29: Advanced Clock Recovery options.....	33
Figure 30: Optional filters.....	33
Figure 31: Filter characteristics.....	34

Figure 32: Band Pass filtering.....	34
Figure 33: Filters options.....	35
Figure 34: Advanced Filter options.....	36
Figure 35: Effect of the Smoothing window.....	37
Figure 36: Configure Sources Autoset options.....	40
Figure 37: Configure Sources Gating options.....	41
Figure 38: Reference voltage levels diagram.....	42
Figure 39: Example of Hysteresis on a noisy waveform.....	43
Figure 40: Autoset Ref Levels options.....	46
Figure 41: Configure Sources Ref Levels options.....	48
Figure 42: Configure Sources Stat pop Limit options.....	49
Figure 43: Control Panel options.....	52
Figure 44: Plots Create menu.....	58
Figure 45: Vert/Horiz menu for a Histogram plot.....	59
Figure 46: Vert/Horiz menu for a Time Trend plot.....	60
Figure 47: Vert/Horiz menu for a Spectrum plot.....	60
Figure 48: Vert/Horiz menu for a Bathtub plot.....	61
Figure 49: Transfer Function Definition options.....	62
Figure 50: Vert/Horiz menu for a Transfer Function plot.....	63
Figure 51: Vert/Horiz menu for a Phase Noise plot.....	63
Figure 52: Locate Window At options.....	65
Figure 53: File Save browser.....	79
Figure 54: File Recall browser.....	80
Figure 55: Recall Recent files example.....	81
Figure 56: Acquisition Timeout options.....	82
Figure 57: Oscilloscope Reference Memory options.....	87
Figure 58: Clock Period measurement selected.....	88
Figure 59: Configuration of a Period measurement.....	88
Figure 60: Configure Sources Ref Levels before an Autoset.....	89
Figure 61: Configure Sources Ref Levels after an autoset.....	89
Figure 62: Statistical results for a Clock Period measurement.....	90
Figure 63: Min/Max statistical results for a Clock Period measurement.....	90
Figure 64: Mean/Std. Dev statistical results for a Clock Period measurement.....	90
Figure 65: Create plots of results.....	91

Figure 66: Results as a Histogram plot	91
Figure 67: Results as a Time Trend plot.....	92
Figure 68: Results as a Spectrum plot.....	92
Figure 69: Clock-to-Output measurement selected	93
Figure 70: Configuration of a Clock-to-Output measurement.....	94
Figure 71: Statistical results for a Clock-to-Output measurement.....	94
Figure 72: Configure Sources Ref Levels for a Clock-to-Output measurement.....	94
Figure 73: Measurements Summary for a Clock-to-Output measurement	95
Figure 74: Ref Levels Summary for a Clock-to-Output measurement	95
Figure 75: Log Statistics for a Clock-to-Output measurement	96
Figure 76: Log File Name dialog.....	96
Figure 77: Path to the stats.csv log file	97
Figure 78: Viewing statistics in a spreadsheet program	97
Figure 79: Log Measurement /configure menu for a Clock-to-Output measurement.....	98
Figure 80: Input Directory Name dialog box.....	99
Figure 81: Save Current Measurements dialog box.....	99
Figure 82: Path to the TC01R1R2.csv log file.....	100
Figure 83: Viewing a data log file in a spreadsheet program	100
Figure 84: Log Worst Case Waveforms configuration for a Clock-to-Output measurement.....	101
Figure 85: Log Worst Case Waveforms dialog	102
Figure 86: Path to the worse case .wfm log files	102
Figure 87: Data Period results for example 1	107
Figure 88: Pattern Length for example 1	108
Figure 89: Rj/Dj results for example 1	109
Figure 90: Spurs for example 1.....	110
Figure 91: Data Period results for example 2	112
Figure 92: Time Trend plot for example 2.....	113

List of Tables

Table 1: Directories and usage.....	7
Table 2: File name extensions.....	8
Table 3: Entering numeric values	9
Table 4: File menus.....	10
Table 5: User interface items	13
Table 6: Measurement definitions	17
Table 7: General measurement definitions	18
Table 8: File menus.....	19
Table 9: Configure Measurement menus and applicable measurements.....	20
Table 10: N-Cycle measurement configuration.....	24
Table 11: TIE: RjDj analysis configuration.....	27
Table 12: Reference Clock Frequency configuration	29
Table 13: PLL Loop Bandwidth configuration.....	31
Table 14: Advanced Clock Recovery configuration.....	33
Table 15: Filters configuration.....	35
Table 16: Advanced Filter configuration.....	36
Table 17: Configure Sources menus	38
Table 18: Configure Sources Autoset configuration.....	39
Table 19: Optimize Horizontal For configuration	40
Table 20: Configure Sources Gating configuration	40
Table 21: Configure Sources Qualify configuration.....	41
Table 22: Configure Sources Ref Levels Autoset configuration	44
Table 23: Configure Sources Ref Levels Autoset configuration	45
Table 24: Configure Sources Ref Levels configuration.....	47
Table 25: Configure Sources Stat pop Limit configuration	48
Table 26: Measurement Summaries menus	49
Table 27: Control Panel functions	51
Table 28: Statistics menus	53
Table 29: Plot types	54
Table 30: Measurements and available plots	55
Table 31: Plots Create menu options	58

Table 32: Vert/Horiz axis options for a Histogram plot	59
Table 33: Vert/Horiz axis options for a Time Trend plot	59
Table 34: Vert/Horiz axis options for a Spectrum plot.....	60
Table 35: Vert/Horiz axis options for a Bathtub plot.....	61
Table 36: Transfer Function Definition configuration.....	61
Table 37: Vert/Horiz axis options for a Transfer Function plot.....	62
Table 38: Vert/Horiz axis options for a Phase Noise plot.....	63
Table 39: Log Statistics configuration	75
Table 40: Log Measurements configuration	76
Table 41: Log Worst Case Waveforms configuration	77
Table 42: Single waveform measurements	119
Table 43: Dual waveform measurements.....	125
Table 44: File menus parameters	129
Table 45: Select Source area parameters	130
Table 46: Math Defs area parameters	131
Table 47: Waveform Edges parameters	131
Table 48: Measurement Range Limits parameters	131
Table 49: Clock-Data-TIE Measurement parameters	132
Table 50: N-Cycle measurement parameters	132
Table 51: Clock Recovery: Reference Clock Frequency parameters	132
Table 52: Clock Recovery: Loop BW parameters	132
Table 53: Advanced Clock Recovery parameters.....	133
Table 54: Filters parameters.....	133
Table 55: Advanced Filter parameter	133
Table 56: TIE: RjDj Analysis parameters (TDSJIT3 v2 Advanced only).....	134
Table 57: Configure Sources Autoset parameters.....	134
Table 58: Configure Sources Gate/Qualify parameters	135
Table 59: Configure Sources Ref Levels parameters.....	135
Table 60: Configure Stat Pop Limit parameters	135
Table 61: Configure Ref Level Autoset Setup Menu parameters.....	136
Table 62: Histogram Vert/Horiz Axis menu parameters	137
Table 63: Time Trend Vert/Horiz Axis menu parameter.....	137
Table 64: Spectrum Vert/Horiz Axis menu parameters.....	137
Table 65: Bathtub Vert/Horiz Axis menu parameters	138

Table 66: Transfer Function Vert/Horiz Axis menu parameters	138
Table 67: Phase Noise Vert/Horiz Axis menu parameters	138
Table 68: Log Statistics menu parameters	139
Table 69: Log Measurements Configure menu parameters	139
Table 70: Log Worst Case Waveforms Configure menu parameters	140
Table 71: Deskew menu parameters	140
Table 72: Acq Timeout menu parameters.....	141
Table 73: Variable: Value command arguments and queries part 1	146
Table 74: Variable: Value command arguments and queries part 2	147
Table 75: Variable:Value command arguments and queries part 3	148
Table 76: Variable:Value command arguments and queries part 4	149
Table 77: Variable:Value command arguments and queries part 5	150
Table 78: Measurement results queries.....	152
Table 79: Measurement names and key.....	153
Table 80: Source names and key	153
Table 81: Plot names and key	153
Table 82: Error codes.....	154

General Safety Summary

Review the following safety precautions to avoid injury and prevent damage to this product or any products connected to it. To avoid potential hazards, use this product only as specified.

Only qualified personnel should perform service procedures.

While using this product, you may need to access other parts of the system. Read the *General Safety Summary* in other system manuals for warnings and cautions related to operating the system.

To Avoid Fire or Personal Injury:

Connect and Disconnect Properly: Do not connect or disconnect probes or test leads while they are connected to a voltage source.

Observe All Terminal Ratings: To avoid fire or shock hazard, observe all ratings and markings on the product. Consult the product manual for further ratings information before making connections to the product.

Do Not Operate With Suspected Failures: If you suspect there is damage to this product, have it inspected by qualified service personnel.

Symbols and Terms: The following terms and symbols may appear in the online help.

 **WARNING:** Warning statements identify conditions or practices that could result in injury or loss of life.

 **CAUTION:** Caution statements identify conditions or practices that could result in damage to this product or other property.

Terms on the Product: The following terms may appear on the product:

DANGER indicates an injury hazard immediately accessible as you read the marking.

WARNING indicates an injury hazard not immediately accessible as you read the marking.

CAUTION indicates a hazard to property including the product.

Symbols on the Product: The following symbol may appear in the product:



CAUTION Refer to Help

Preface

The TDSJIT3 v2 application consists of two products: Jitter Analysis Advanced and Jitter Analysis Essentials. These products are applications that enhance basic capabilities of some Windows-based oscilloscopes from Tektronix. These jitter analysis applications include the following features:

- Select and configure multiple measurements on more than one waveform
- Display statistical results for up to six measurements
- Perform random and deterministic jitter analysis including BER estimation (TDSJIT3 v2 Advanced only)
- Show results as plots
- Save statistical results to a data log file
- Save individual data points to a measurement results file
- Save the worst case waveforms to .wfm files

5-Time Free Trial

A 5-time free trial is available for all applications in the "Applications on this CD and Compatible Oscilloscope" table found in the *Optional Applications Software on Windows-Based Oscilloscope Installation Manual* (accessible as a PDF file.) You can start and exit an application up to five times to help you evaluate Tektronix software solutions.

If an application becomes available after you receive your oscilloscope, you can download the application as described in the installation manual to try the free trial.

Related Documentation

Refer to the *Optional Applications Software on Windows-Based Oscilloscope Installation Manual* for the following information:

- Software warranty
- List of all available applications, compatible oscilloscopes, and relevant software and firmware version numbers
- Applying a new label
- Installing an application
- Enabling an application
- Downloading updates from the Tektronix Web site

Note: You can view PDF file of the installation manual from the CD Installation Browser and from the Documents directory on the *Optional Applications Software on a Windows-Based Oscilloscope CD-ROM*.

GPIB Information

For information on how to operate the oscilloscope and use the application-specific GPIB commands, refer to the following items:

- The user manual for your oscilloscope provides general information on how to operate the oscilloscope.
- The online help for your oscilloscope can provide details on how to use GPIB commands to control the oscilloscope if you install the GPIB Programmer guide (and code examples) from the oscilloscope CD-ROM.
- The example directory for programming examples of how to remotely control the application. The default location for the example files is C:\TekApplications\TDSJIT3v2\Examples\GPIB-Examples.

Relevant Web Sites

The Tektronix Web site offers the following information:

- *Understanding and Characterizing Jitter Primer*, part number 55W-16146-1
- Jitter analysis details on the www.tektronix.com/jitter web page

You can also find useful information in the Fibre Channel - Methodologies for Jitter and Signal Quality Specification – MJSQ on the www.t11.org web site.

Application CD Contents

The *Optional Applications Software on a Windows Based Oscilloscope CD-ROM* includes files for the following types of documentation:

- Printable file of the TDSJIT3 v2 Jitter Analysis online help formatted to resemble a user manual
- Reference guides
- Optional Applications Installation manual

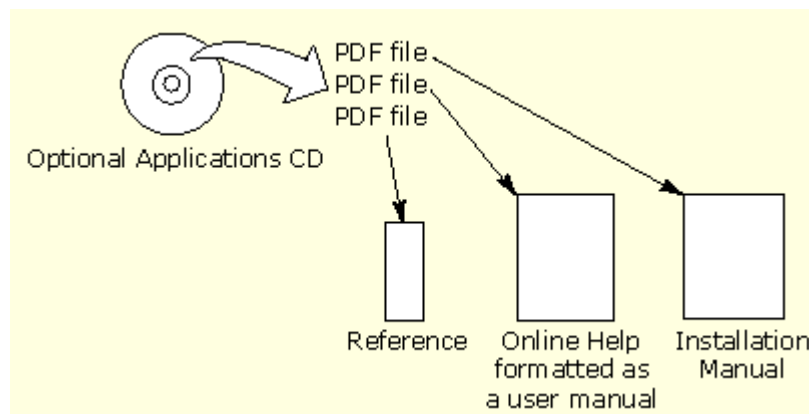

Figure 1: Contents of the application CD-ROM

You can use the following methods to view most PDF files associated with this application:

- Access a file in the Documents directory on the Optional Applications Software on a Windows-Based Oscilloscope CD-ROM from any PC
- Access a file from the CD Installation Browser
- Select a file (except Reference guides) from the Start menu in the oscilloscope task bar; you may need to minimize the oscilloscope and minimize the application
- Use the Manuals Finder from the www.tektronix.com web site.

You can also use this additional method to view only the PDF file of the online help:

- Select the shortcut on the desktop of the oscilloscope after you minimize the oscilloscope

Note: If you do not have an Acrobat reader to view a PDF file, you can get a free copy of the reader from the www.adobe.com/products/acrobat web page.

Conventions

Online help topics use the following conventions:

- The terms "TDSJIT3 v2 application" or "application" refer to the TDSJIT3 v2 Advanced or TDSJIT3 v2 Essentials Jitter Analysis Application (except when noted as Advanced only).
- The term "oscilloscope" refers to any product on which this application runs.
- The term "select" is a generic term that applies to the two mechanical methods of choosing an option: with a mouse or with the Touch Screen.
- The term "DUT" is an abbreviation for Device Under Test.
- User interface screen graphics are from a TDS7000 series oscilloscope; there may be minor differences in the displays on other types of oscilloscopes.
- When steps require a sequence of selections using the application interface, the ">" delimiter marks each transition between a menu and an option. For example, one of the steps to recall a setup file would appear as File> Recall.

Types of Online Help Information

The online help contains the following types of information:

- A Getting Started group of topics briefly describes the application, contains connection procedures, and includes a deskew procedure.
- An Operating Basics group of topics covers basic operating principles of the application, including the Jitter Wizard. The sequence of topics reflects the steps you perform to operate the application and includes definitions for all menus and options.
- A Tutorial group of topics teaches you how to set up the application to acquire a waveform, take a measurement, view the results, view a plot, and save data to a file.

- An Application Examples group of topics demonstrates how to use jitter measurements to identify a problem with a waveform. This should give you ideas on how to solve your own measurement problems.
- A Reference group of topics specifies the minimum, maximum, incremental, or list of choices, and the default values for all adjustable parameters.
- A Measurement Algorithms group of topics includes measurement guidelines and information on how the application calculates each measurement.
- A GPIB Command Syntax group of topics contains a list of arguments and values that you can use with the remote commands and their associated parameters. The application includes simple remote interface programs to show you how to operate the application using GPIB commands.

The application installs a desktop shortcut to access a PDF file of the help topics. The file is printable and is formatted to resemble a user manual.

Using Online Help

Online help has many advantages over a printed manual because of advanced search capabilities. You can select Help> Topics on the right side of the application menu bar to display the Help file.

The main (opening) Help screen shows a series of book icons and three tabs along the top menu, each of which offers a unique mode of assistance:

- **Table of Contents (TOC) tab** - organizes the Help into book-like sections. Select a book icon to open a section; select any of the topics listed under the book.
- **Index tab** - enables you to scroll a list of alphabetical keywords. Select the topic of interest to display the corresponding help page.
- **Find tab** - allows a text-based search. Follow these steps:
 1. Type the word or phrase you wish to find in the search box.
If the word or phrase is not found, try the Index tab.
 2. Select some matching words in the next box to narrow your search.
 3. Choose a topic in the lower box, and then select the Display button.

Note: The Find tab function does not include words found in graphics. Refer to the Find Tab and Searches topic for more information.

A **Note:** in the topic text indicates important information.



Tip When you use a mouse, you can tell when the cursor is over an active hyperlink because the arrow cursor changes to a small pointing hand cursor.

The light bulb icon and word Tip in the graphic above indicates additional information to help you operate the application more efficiently.

Find Tab and Searches

Many online help topics only contain tables. To retain vertical and horizontal lines, the tables are graphical objects. The Find tab in the online help does not recognize words in these tables.

The online help is extensively indexed with the proper names of all menus and options as they appear in the application and in the left column of graphical tables.

Note: If you conduct a Find tab search with no results, try the Index tab instead.

Feedback

Tektronix values your feedback on our products. To help us serve you better, please send us suggestions, ideas, or other comments you may have about your application or oscilloscope.

You can email your feedback to techsupport@tektronix.com, FAX at (503) 627-5695, or by phone. Please be as specific as possible and include the following information:

General Information

- Oscilloscope model number and hardware options, if any
- Probes used
- Serial data standard
- Signaling rate
- Your name, company, mailing address, phone number, FAX number

Note: Please indicate if you would like to be contacted by Tektronix regarding your suggestion or comments.

Application-Specific Information

- Software version number
- Description of the problem such that technical support can duplicate the problem
- If possible, save the oscilloscope waveform file as a .wfm file
- If possible, save the oscilloscope and application setup files from the application to obtain both the oscilloscope .set file and the application .ini file. Refer to Saving a Setup File.

Once you have gathered this information, you can contact technical support by phone or through e-mail. If using e-mail, be sure to enter "TDSJIT3 v2 Problem" in the subject line, and attach the .set, .ini, and .wfm files.



Tip To include screen shots, from the oscilloscope menu bar, select File> Export. In the Export dialog box, enter a file name with a .bmp extension and select Save. The file is saved in the C:\TekScope\Images directory. You can then attach the file to your email (depending on the capabilities of your email editor).

Getting Started

The TDSJIT3 v2 application consists of two products: Jitter Analysis Advanced and Jitter Analysis Essentials. These products are applications that enhance basic capabilities of some Windows-based oscilloscopes from Tektronix. The application includes a Wizard to help you quickly set up measurements and obtain measurement results.

You can use this application to do the following tasks:

- Select and configure multiple measurements on one or more waveforms
- Display statistical results for up to six measurements
- Perform random and deterministic jitter analysis including BER estimation (TDSJIT3 v2 Advanced only)
- Apply high pass and low pass filters to the measurements (TDSJIT3 v2 Advanced only)
- Display the results as Histogram, Time Trend, Cycle Trend, and Spectrum plots; for TDSJIT3 v2 Advanced only, also display the results as Bathtub, Transfer Function, and Phase Noise plots
- Export plots
- Log statistical results to a file
- Log individual data points to a measurement results file
- Log worst case waveforms to files

Note: There are no standard accessories for this product.

Differences between TDSJIT3 v2 Advanced and TDSJIT3 v2 Essentials

The TDSJIT3 v2 Advanced application provides the following features that are not included in the TDSJIT3 v2 Essentials application:

- PLL-Based Clock Recovery
- Crossover Voltage Analysis
- Jitter separation (Rj/Dj analysis)
- Bit error rate estimation (BER)
- Filters
- Bathtub, Transfer Function, and Phase Noise plots

Features that are only available with the TDSJIT3 v2 Advanced application are indicated as "TDSJIT3 v2 Advanced only."

Compatibility

For information on oscilloscope compatibility, refer to the product data sheet (use the Search tool on the www.tektronix.com web site) or the *Optional Applications Software on Windows-Based Oscilloscopes Installation Manual*, Tektronix part number 071-1888-XX. The manual is also available as a PDF file.

The setup files for TDSJIT3 v2 Advanced and TDSJIT3 v2 Essentials are compatible with each other.

The TDSJIT3 v2 Advanced application will recall setup files made with previous versions of TDSJIT3 and TDSJIT3E. To convert an existing setup file, recall it and then save it again. If you wish to retain a copy of the original setup file, use a different filename when saving. Note that setup files from previous versions may include directory paths such as "C:\TekApplications\TDSJIT3\...", whereas the v2 application defaults to "C:\TekApplications\TDSJIT3v2\...". If you would like your converted setup files to use the TDSJITv2 directory, recall the existing setup file, use the Graphical User Interface to change any file paths to use the new directory structure, and then save the setup.

Requirements and Restrictions

The Sun Java Run-Time Environment (JRE) V1.4.2 must be installed on the oscilloscope to operate the TDSJIT3 v2 application. When you install the application, the InstallShield Wizard automatically installs the proper version of the JRE. If the JRE is deleted, install TDSJIT3 v2 application again.

Memory. A minimum of 512 MB PC memory is required and 1 GB PC memory is highly recommended.

Keyboard. You will need to use a keyboard to enter new names for some file save operations.

Accessories

There are no standard accessories for this product. However, you can refer to the product datasheet available on the Tektronix Web site for information on optional accessories relevant to your application.

Installation

Refer to the *Optional Applications Software on Windows-Based Oscilloscope Installation Manual* for the following information:

- Installing an application
- Applying a new label
- Enabling an application
- Downloading updates from the Tektronix Web site

Connecting to a Device Under Test (DUT)

You can use any compatible probes or cable interface to connect between your DUT and oscilloscope. One connection is sufficient for most signals.

The Clock-to-Output, Skew, and Crossover Voltage (TDSJIT3 v2 Advanced only) measurements require two input channels, two reference, or two Math waveforms.

 **Warning:** To avoid electric shock, remove power from the DUT before attaching probes. Do not touch exposed conductors except with the properly rated probe tips. Refer to the probe manual for proper use.

Refer to the General Safety Summary in your oscilloscope manual.

Deskewing Probes and Channels

To ensure accurate results for two-channel measurements, it is important to first deskew the probes and oscilloscope channels before you take measurements from your DUT.

The application includes an automated deskew utility that you can use to deskew any pair of oscilloscope channels.

Note: To produce the best deskew results, you should connect the probes to the fastest signal in your DUT.

Deskewing on Oscilloscopes with Bandwidth Extension

Some Tektronix oscilloscopes feature software-based bandwidth extension. The bandwidth extension may be enabled on a per-channel basis.

Enabling or disabling bandwidth extension on any channel affects the skew on that channel. Thus, you should deskew probes and channels after you make such configuration changes.

Steps to Deskew Probes and Channels

To deskew a pair of probes and oscilloscope channels, follow these steps:

1. Refer to Connecting to a Device Under Test before starting the procedure.
2. Connect both probes to the fastest signal in your DUT.

Set up the oscilloscope as follows:

1. Use the Horizontal Scale knob to set the oscilloscope to an acquisition rate so that there are two or more samples on the deskew edge.
2. Use the Vertical Scale and Position knobs to adjust the signals to fill the display without missing any part of the signals.
3. Set the Record Length so that there are more than 100 edges in the acquisition.
4. Start the TDSJIT3 v2 application.
5. Select Utilities> Deskew. The Deskew Utility menu appears.
6. Set the Reference Source option to Ch1. The Source waveform is the reference point used to deskew the remaining channels.
7. Set the Target Source option to Ch2. This is the channel that will be deskewed.
8. To start the utility, select the Perform Deskew command button, and then select Yes.

9. Repeat steps 7 and 8 for Ch3, and then for Ch4 to deskew those channels.
10. To view the deskew values, select the Summary button.

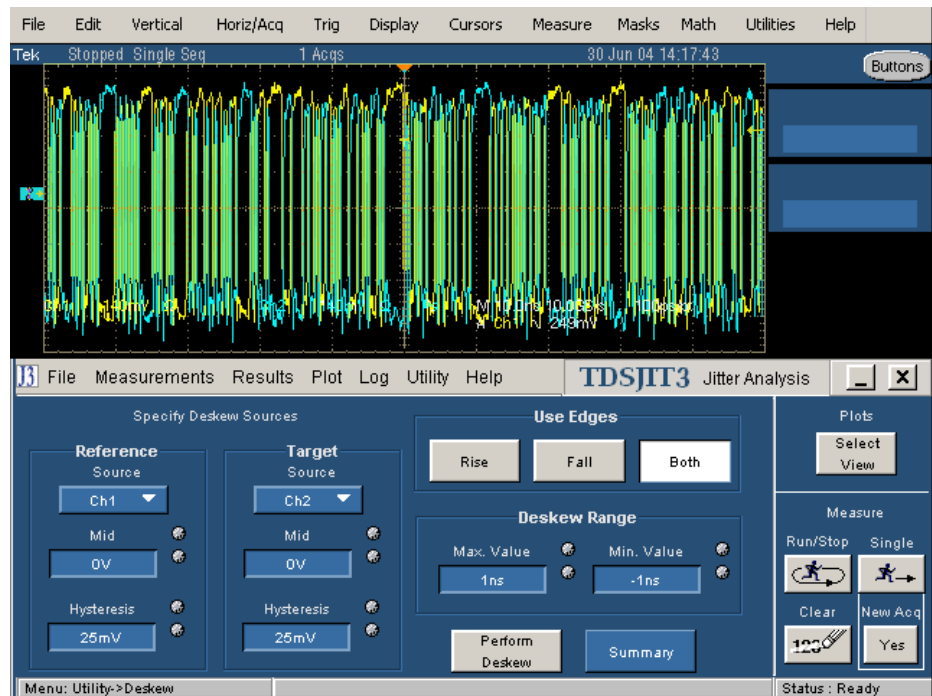

Figure 2: Deskew complete example

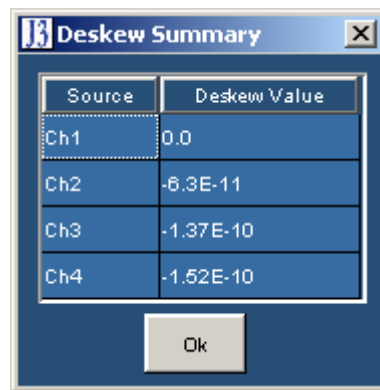

Figure 3: Deskew Summary example

Operating Basics

The topics in the Operating Basics book cover the following definitions and tasks:

- General information, such as on navigating the user interface
- Setting up the application
- Taking measurements
- Viewing the measurement results as statistics or as plots
- Using the plot window zoom and cursors functions
- Exporting Plot Files
- Logging statistical results to a file
- Logging individual data points to a file
- Logging worst case waveforms to files
- Saving and recalling setup files

General Information

Starting the TDSJIT3 v2 Application

The way you start the application depends on the oscilloscope model. To start the application, do one of the following:

- Select App > Jitter Analysis – Advanced
- Select File > Run Application > Jitter Analysis – Advanced in the oscilloscope menu bar
- Select Analyze > Jitter Analysis – Advanced

If you are using the TDSJIT3 v2 Essentials application, select Jitter Analysis - Essentials.

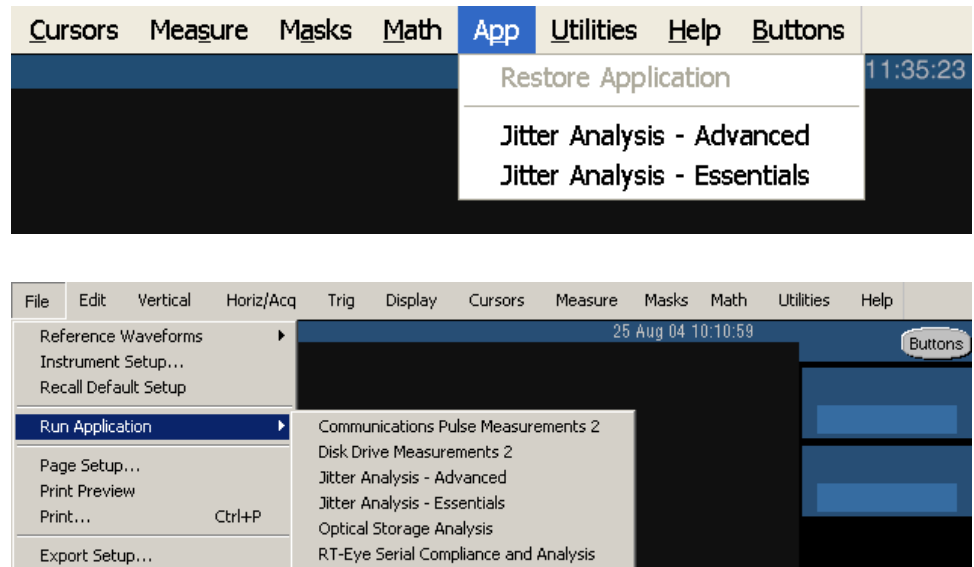

Figure 4: Starting the TDSJIT3 v2 application

Returning to the Application

The way you return to the application depends on the oscilloscope model.

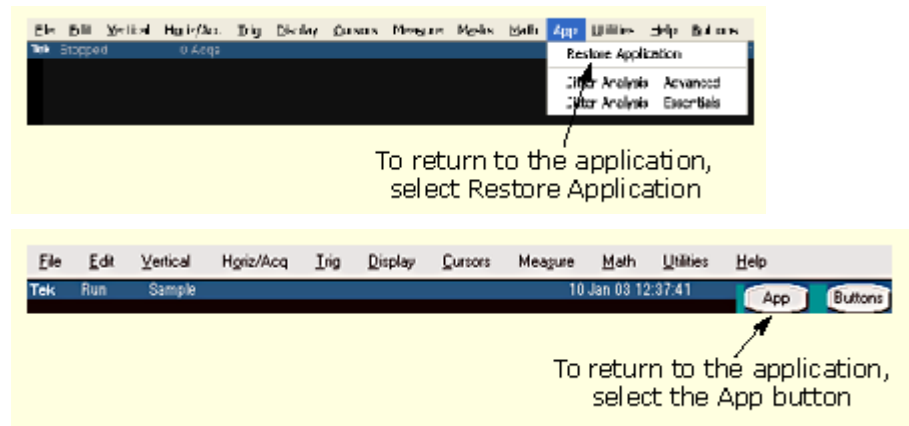



Figure 5: Returning to the application

Minimizing and Maximizing the Application

To minimize the application, select File> Minimize or the  command button in the application menu bar. When you minimize the application, the oscilloscope fills the display.

To maximize the application, select  in the oscilloscope task bar.

Exiting the Application

To exit the application, select File> Exit or the  command button in the application menu bar. When you exit the application, you can choose to keep the oscilloscope setup currently in use with the application or to restore the oscilloscope setup that was present before you started the application.

Application Directories and Usage

During installation, the application sets up directories for various functions, such as to save setup files, and uses extensions appended to file names to identify the file types.

Table 1: Directories and usage

Default directory names*	Directory use
\TDSJIT3v2	Home location
\TDSJIT3v2\Examples\GPIB-Examples	Examples of remote control programs that use GPIB commands
\TDSJIT3v2\Examples\waveforms	Waveform files used in the tutorial and application examples
\TDSJIT3v2\log	Statistics log files
\TDSJIT3v2\measurements	Log files of data points for each selected measurement
\TDSJIT3v2\measurementsSnapshot	Measurement log files for the Save Current Measurements option (Log Measurements)
\TDSJIT3v2\patterns	Pattern files for the Advanced Clock Recovery configuration
\TDSJIT3v2\plotData	Data exported from measurement plots
\TDSJIT3v2\plotFigures	Image files exported from measurement plots
\TDSJIT3v2\setup	Setup files
\TDSJIT3v2\waveforms	Worst case waveforms files
* All subdirectories are located in the C:\TekApplications directory.	

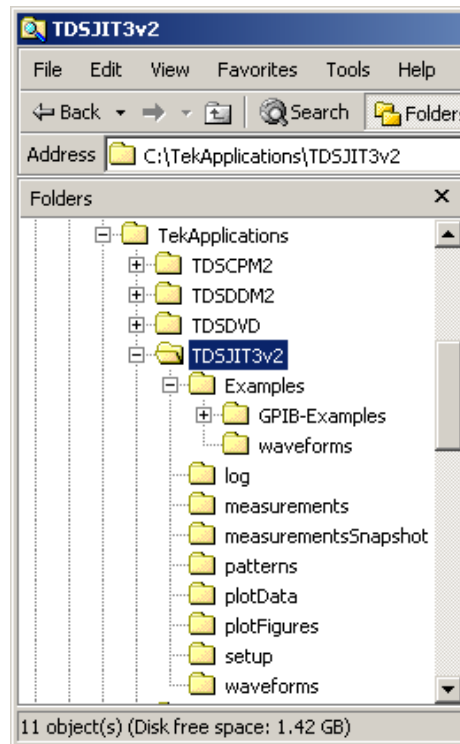

Figure 6: Directory structure



Table 2: File name extensions

Extension	Description
.bmp	File that uses a "bitmap" format
.csv	File that uses a "comma separated value" format
.ini	TDSJIT3 application setup file
.jpg	File that uses a "joint photographic experts group" format
.mat	File that uses native MATLAB binary format
.png	File that uses a "portable network graphics" format
.set	Oscilloscope setup file that is recalled with an application .ini file; both files will have the same name
.txt	File that uses an ASCII format
.wfm	Waveform file; can be recalled into Reference memory

Tips on the TDSJIT3 v2 User Interface



Here are some tips to help you with the application user interface:

- Use the Jitter Wizard to set up and take one measurement from a set of commonly used measurements
- Select a Source before selecting each measurement
- Select any waveform source and any measurement multiple times to use different configuration options

- Use the Single run button  to obtain a single set of measurements from a single run; push the button again to interrupt the acquisition
- Use the Run/Stop button  to acquire measurements from continuous runs; push the button again to interrupt the current acquisition, or push the Single button to stop sequencing when the current acquisition and measurement cycle is complete

How to Enter Numeric Values

Table 3: Entering numeric values

Method	Description
 Keypad	Displays the virtual keypad (looks similar to a calculator); use to enter a value
 Multipurpose knob*	Displays a line between the icon and the option box to indicate that either the upper or lower multipurpose knob on the front panel of the oscilloscope is active; turn the knob to select a value Press the FINE button on the oscilloscope to enter or select the smallest values or units
Edit box*	Type in a value from the physical keyboard and press the Enter key
* When selected twice, the Keypad appears.	

Virtual Keypad

Note: Select the  icon, and then use the virtual keypad to enter information, such as reference voltage levels.

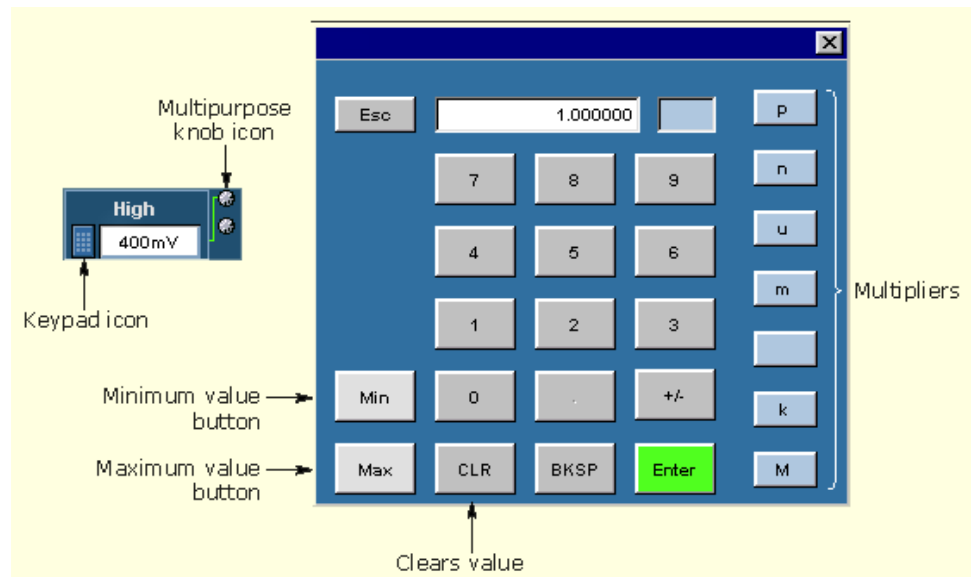

Figure 7: On-screen keypad

Using Basic Oscilloscope Functions

You can use oscilloscope controls and functions while the application is running. To do so, select a menu from the oscilloscope Menu bar (or Toolbar) and access menus, or use the front-panel knobs and buttons. You can also use the oscilloscope Help menu to access information about the oscilloscope and how to use it.

When you access some oscilloscope controls, the oscilloscope fills the display.

File Menus

You can use the File menus to save and recall different application setups and recently accessed files.

Do not edit a setup file or recall a file not generated by the application.

Table 4: File menus

Menu/function	Description or function
Default Setup	Recalls most default (startup) parameters
Recall*	Browse to select an application setup (.ini) file to recall; restores the application to the values saved in the setup file
Save*	Saves the current application settings in a .ini file
Recent Files	Select from a list of the four most recently accessed setup files (saved or recalled) and recall that setup
Dock	Positions and locks the TDSJIT3 v2 application in the lower half of the oscilloscope display and the oscilloscope application in the upper half of the display
Undock	Unlocks and allows you to move the TDSJIT3 v2 application to another position in the oscilloscope display or to a second monitor; the oscilloscope display returns to full size
Minimize	Minimizes the application
Exit	Exits the application; you can choose to retain the current oscilloscope settings or restore the oscilloscope to settings prior to starting the application
*Save or Recall functions also save or recall the associated oscilloscope setup file (.set); an oscilloscope file is recalled if the application finds a .set file with a matching name.	

Navigating the User Interface

The application provides you with several methods to set up the application:

- The Jitter Wizard
- The Measurement Setup Sequence buttons
- The menus available in the menu bar

The Jitter Wizard allows you to set up, configure, and launch a single measurement without requiring any knowledge of the control menus. However, it does not provide access to many of the advanced features.

The Measurement Setup Sequence buttons show the logical order you would follow to set up the application if you do not use the Jitter Wizard.

The menus from the menu bar allow the same full control as the Measurement Setup Sequence buttons, but are accessible at all times.

General Steps to Set Up the Application

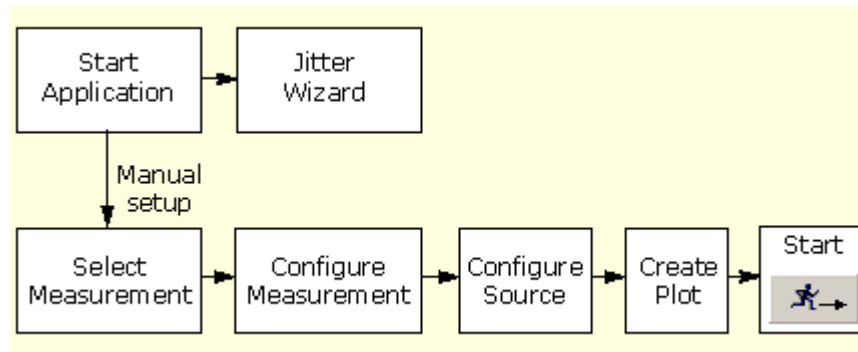

Figure 8: General steps to set up the application

Jitter Wizard

The Jitter Wizard provides a quick and easy graphical interface that guides you through a short series of menus so you can take measurements in the fewest steps possible. The wizard lets you pick one measurement from a subset of measurements, and then take a single measurement only. (The application can take six measurements simultaneously.)

The selections you make in each wizard menu determine the subsequent choices the wizard offers in the next selection menu. You can use several methods to configure the wizard: by preference selections, by default selections, or a combination of both.

Note: You can set the Jitter Wizard menu to always appear when you start the application.

To quickly take measurements, follow these steps:

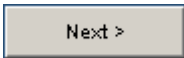
1. Select Measurements> Wizard or select Help> Wizard to launch the Jitter Wizard.
2. Select a measurement category.
3. Select the  button in each subsequent menu to use all the default settings.

4. Select the  button.

The wizard closes, the application takes the measurement, and displays statistical results.

Note: The statistical results when you use the wizard are identical to the results when you do not use the wizard if the measurement and setup are the same.

When you are through setting up a measurement and plots with the wizard, select the Run button. The application takes the measurement and displays the results,

including selected plots. To obtain new measurement results, select the  Single Run button.

If you select the Cancel button, the wizard exits and discards all of the selections.

Note: After you use the wizard, you may decide to refine some options, such as the calculated values for reference voltage levels, to suit your analysis situation.

Note: The application does not launch the Jitter Wizard when you start the application if you clear the Show This Wizard At Startup option.

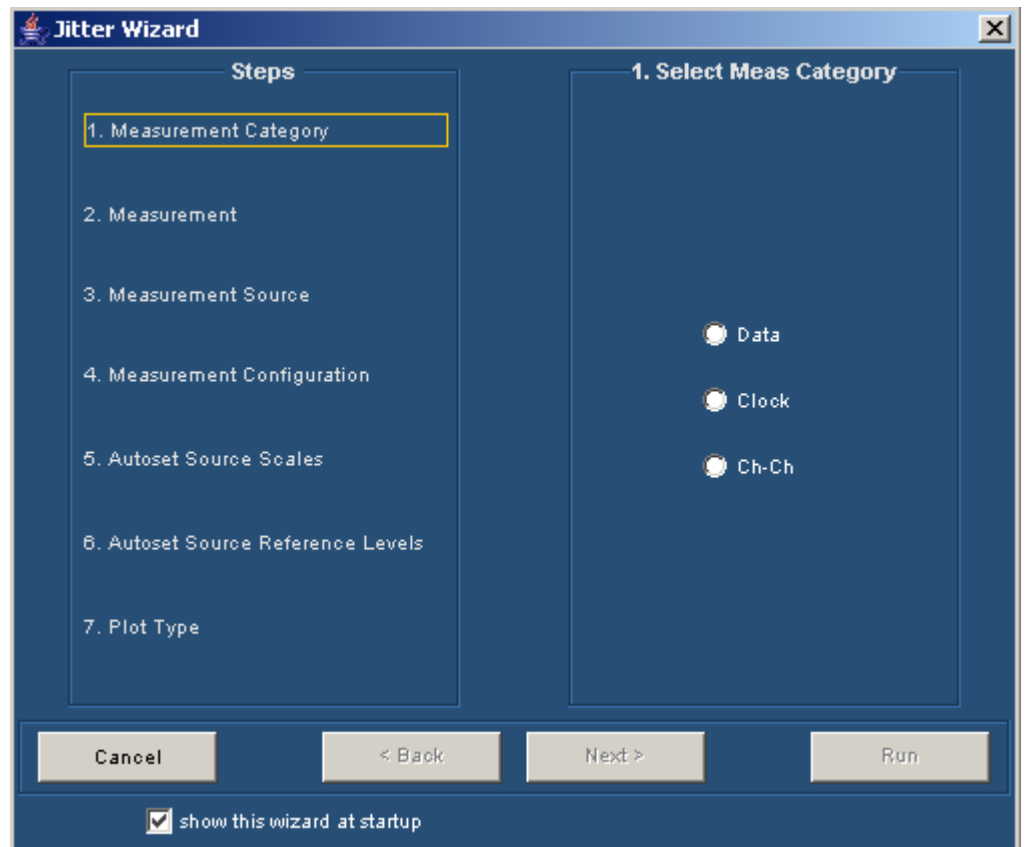

Figure 9: Jitter Wizard when launched

User Interface Information

The application uses a Microsoft Windows based user interface. Display the definitions of the application user interface items, or view a menu labeled with the user interface items.

Note: The oscilloscope application shrinks to half size and appears in the top half of the screen when the application is running.

Table 5: User interface items

Item	Description
Area	Visual frame that encloses a set of related options
Box	Use to define an option; enter a value with the Keypad or a Multipurpose knob
Browse	Displays a window where you can look through a list of directories and files
Button	Use to define an option; not a command button
Check box	Use to select or clear an option
Command button	Initiates an immediate action, such as the Start command button in the Control panel
Control panel	Located to the right of the application; contains command buttons that you use often, such as to Start sequencing
Keypad	On-screen keypad that you can use to enter numeric values
List box	Use to select an option from a list
Menu	All options in the application window (except the Control panel) that display when you select a menu bar item
Menu bar	Located along the top of the application display and contains application menus
Multipurpose knob	Icon that indicates when you can use one of the multipurpose knobs on the oscilloscope front panel to adjust a value
Option	Any named button (other than a command button) or any named box that defines a control or task
Status bar	Line located at the bottom of the application display that shows the name of the current menu (location) and the latest Warning or Error message
Tab	Short cut to a menu in the menu bar or a category of menu options; most tabs are short cuts
Virtual keyboard	On-screen keyboard that you can use to enter alphanumeric strings, such as for file names
Scroll bar	Vertical or horizontal bar at the side or bottom of a display area that you use to move around in that area

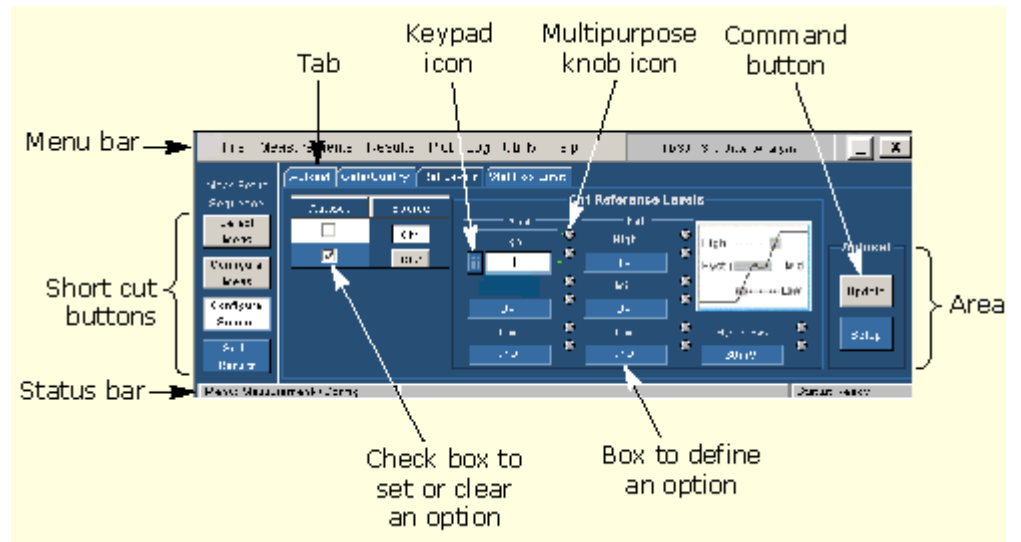

Figure 10: Menu with user interface items

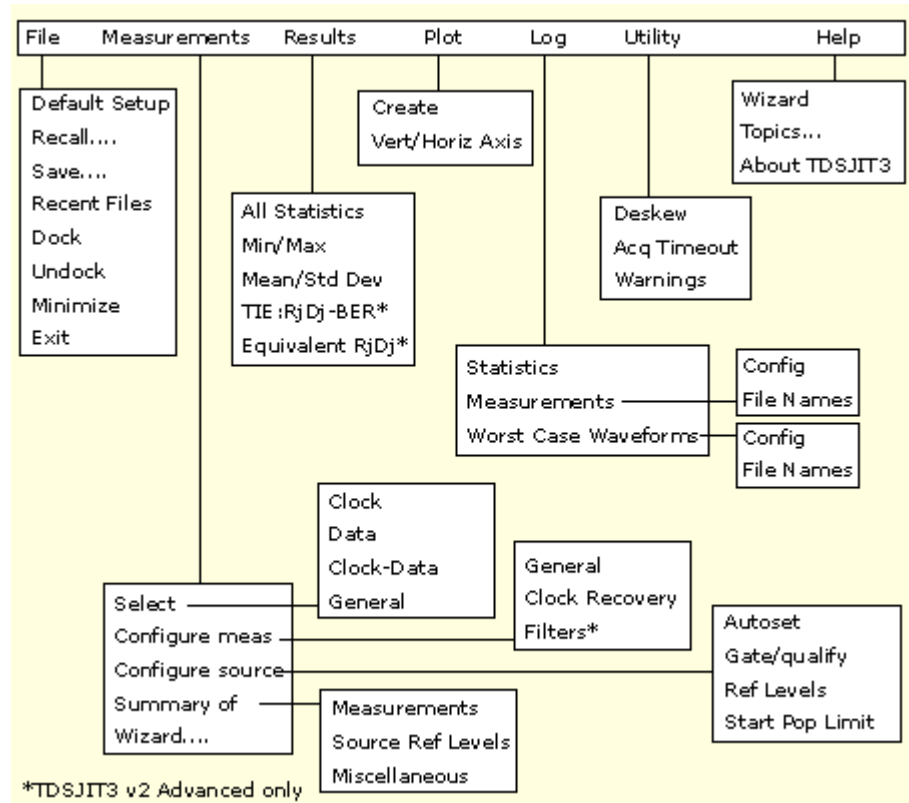

Figure 11: Menu navigation tree



Setting Up the Application for Analysis

The Jitter Wizard allows you to set up, configure, and launch a single measurement without requiring any knowledge of the control menus. However, it does not provide access to many of the advanced features.

The Measurement Setup Sequence buttons show the logical order you would follow to set up the application if you do not use the Jitter Wizard. The menus from the menu bar allow the same full control as the Measurement Setup Sequence buttons, but are accessible at all times.

When you use the Measurement Setup Sequence buttons or the menus, you may need to perform some or all of the following tasks:

- Select up to six measurements
- Configure measurement options
- Configure waveform sources, such as the Source Autoset function
- Create and configure up to four plots
- Log statistics, measurements, or worst case waveforms
- Take measurements and display the results

After setting up the application, you can select the  or  command button to take measurements. The application displays the results as statistics, and as plots if you set up the Plot Create menu.

After taking measurements, you can do any of the following tasks:

- View the results as statistics
- View the results graphically

Selecting Measurements

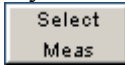
You can use the Measurements Select menu to select up to six measurements. You can always access the menu by selecting Measurements> Select in the menu bar. In addition, you can use the  button (when visible) as a short cut to the Measurements Select menus.

To select a measurement, always choose the Source (or sources) first, and then select a measurement. To select a measurement, follow these steps:

1. Select the Source in the Select Source area.
2. Select a measurement in the Add Measurement area.
3. For some advanced configurations, use the options in the Math Defs area in conjunction with the Source Select area.

You can select the same measurement type multiple times using different sources. To do so, select a source first, and then select a measurement. You can also create two or more measurement entries that use the same measurement type and source, and then configure each measurement differently.

You can view the configured measurements, sources, and any associated values in various Measurement Summary menus.

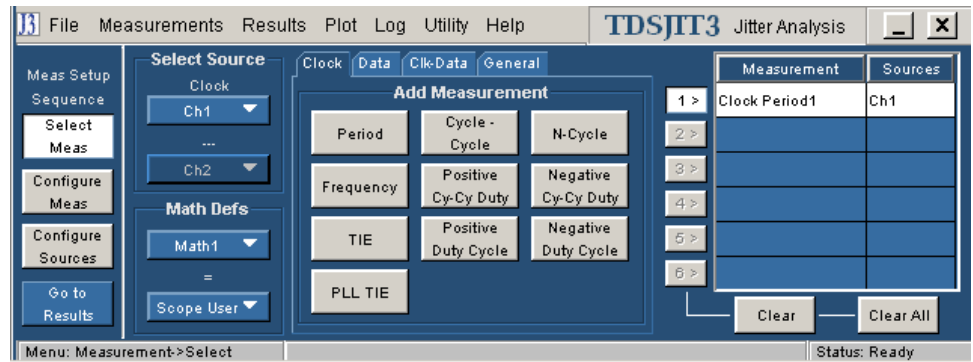

Figure 12: Measurements Select menu

Select Source Area

The application takes measurements from waveforms specified as sources (also called input sources). You can select a live channel (CH1, CH2, CH3, or CH4), a reference (Ref1, Ref2, Ref3, or Ref4), or a math (Math1, Math2, Math3, or Math4) waveform as a source.

The titles above the Select Source option list boxes vary depending on the measurement category.

Note: Most measurements require one source. The Setup, Hold, Clock-to-Output, Skew, and Crossover Voltage (TDSJIT3 v2 Advanced only) measurements require two sources.

Option names (in the Select Source area) vary with the category of measurements.

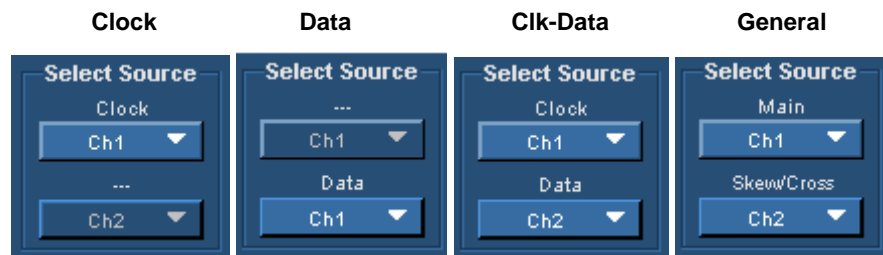

Figure 13: Select Source options by measurement category

Table 6: Measurement definitions

Area	Option	Description
Clock	Period	Elapsed time between consecutive crossings of the mid reference voltage level by the waveform in the specific direction; see the Common Cycle Start Edge option
	Frequency	Inverse of the period for each clock cycle
	TIE	Difference in time between each edge of a designated polarity on a sampled clock waveform to the corresponding edge on a calculated clock waveform with a constant frequency (zero jitter)
	PLL TIE	Measurement errors relative to a timing reference that is recovered from a data stream by a phase locked loop (PLL); for TDSJIT3 v2 Advanced only
	Cycle-Cycle	Difference in period measurements from one cycle to the next
	N-Cycle	Difference in elapsed time between two consecutive groups of N-Cycles where N is a configuration object that you can set
	Positive Cy-Cy Duty	Difference between two consecutive positive widths
	Negative Cy-Cy Duty	Difference between two consecutive negative widths
	Positive Duty Cycle	Ratio of the positive portion of the cycle relative to the period
	Negative Duty Cycle	Ratio of the negative portion of the cycle relative to the period
Data	Period	Elapsed time between when a waveform crosses specific reference voltage levels in the opposite direction once
	Frequency	Inverse of the period for each data cycle
	TIE	Difference in time between the data edges on an acquired data waveform to the data edges on a recovered data waveform with a constant rate (zero jitter)
	PLL TIE	Measurement errors relative to a timing reference that is recovered from a data stream by a phase locked loop (PLL); for TDSJIT3 v2 Advanced only
Clk-Data	Setup	Elapsed time between when a data waveform crosses a voltage reference level followed by the clock signal crossing its own voltage level
	Hold	Elapsed time between when the clock waveform crosses a voltage reference level followed by a data waveform crossing its own voltage level
	Clk-Out	Elapsed time between when the clock waveform crosses a voltage reference level followed by an output waveform crossing its own voltage level
	TIE	Difference in time between the data edges on an acquired waveform to the corresponding edges of an acquired clock waveform of designated polarity

Table 7: General measurement definitions

Area	Option	Description
General	Rise Time	Time difference between when the Lo reference level is crossed and the Hi reference level is crossed on the rising edge of the waveform
	Fall Time	Time difference between when the Hi reference level is crossed and the Lo reference level is crossed on the falling edge of the waveform
	Positive Width	Amount of time the waveform remains above the mid reference voltage level
	Negative Width	Amount of time the waveform remains below the mid reference voltage level
	High Time	Amount of time the waveform remains above the high reference voltage level
	Low Time	Amount of time the waveform remains below the high reference voltage level
	Skew	Difference in time between two similar edges on two waveforms with the assumption that every edge in one waveform has a corresponding edge (either the same or opposite polarity) in the other waveform; edge locations are referenced to the mid reference voltage level
	Crossover Voltage	Edge timing derived from the crossover (voltage) of differential clock or data measurements; for TDSJIT3 v2 Advanced only

Math Definitions

The application includes four preset math operations and an option to use any other math operation as defined in the oscilloscope. You can assign each math waveform (Math1, Math2, Math3, or Math4) to any of these five operations.

The Math Defs area includes the following preset math operations:

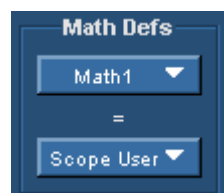

- Ch1-Ch3
- Ch2-Ch4
- Ref1-Ref2
- Ref3-Ref4

You can select Scope User if you want to use a math waveform based on a user-defined math operation. To define your own math operation, use the oscilloscope math equation editor.

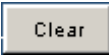

Clearing Measurements

You can remove individual or all selected measurements through the Measurements Select menu. To remove an individual measurement, follow these steps:

1. Select the measurement to be removed in the table on the right side of the Measurements Select menu.
2. Select the  button.
3. To remove all selected measurements, select the  button.

Configuring a Measurement

Most measurements offer configuration options. The options available in each Configure Measurement menu are specific to the selected measurement.

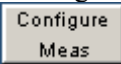
You can always access the menus by selecting Measurements> Configure in the menu bar. In addition, you can use the  button (when visible) as a short cut to the Configure Measurements menus.

The application includes the following Configure Measurement menus:

- General
- Clock Recovery
- Filters (TDSJIT3 v2 Advanced only)

Configure Measurement Menus Definitions

Table 8: File menus

Menu name	Description
General	Define waveform edges; define range limits for some measurements
Clock Recovery	Define reference clock frequency or PLL loop bandwidth for some measurements; advanced functions
Filters*	Define high pass, low pass, or band pass filters; advanced functions
* TDSJIT3 v2 Advanced only.	

Table 9: Configure Measurement menus and applicable measurements

Measurements	General	Clock recovery	Filters*
Clock TIE Clock PLL TIE*	Yes**	Yes	Yes
Data TIE Data PLL TIE*	Yes**	Yes	Yes
Clock Period Clock Frequency	Yes	---	Yes
Data Period Data Frequency	---	Yes	Yes
Cycle-Cycle N-Cycle Positive Duty Cycle Negative Duty Cycle Setup Hold Clk-Out Clock-Data Skew Crossover Voltage*	Yes Yes**	---	---
Positive Cy-Cy Duty Negative Cy-Cy Duty Rise Time Fall Time Positive Width Negative Width High Time Low Time	None†		
* TDSJIT3 v2 Advanced only.			
** TIE: RjDj configure options are for TDSJIT3 v2 Advanced only.			
† No configuration options are available for these measurements.			

General

You can select which waveform edge the application will use to take measurements. The name of the edge option depends on the measurement being configured.

Edge options appear in the General Configure Measurement menu. Some measurements include two edge options because they require two waveforms.

Note: Data measurements do not include Waveform Edge options.

Clock Edge Options

The Clock Edge option defines which edge of the clock input is used to calculate the statistics of clock based measurements.

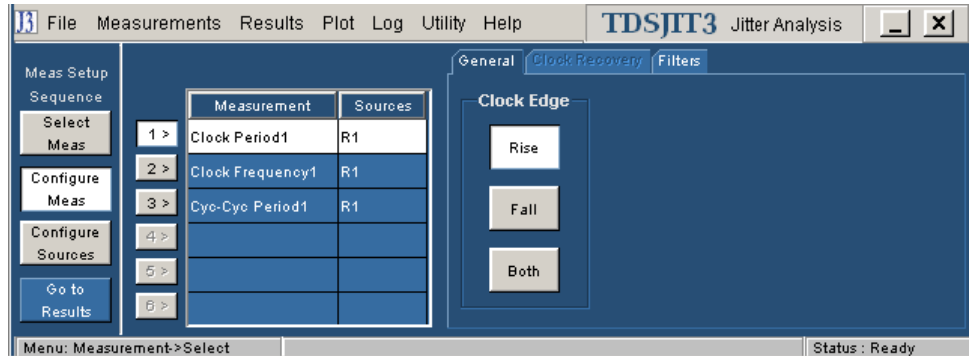

Figure 14: Clock edge options

Active Edge Options

The Active Edge option defines which edge of the source waveform is used to take measurements.

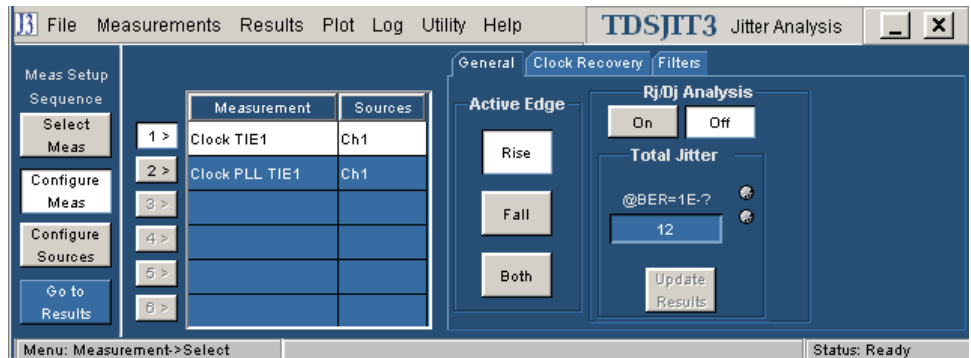

Figure 15: Active edge options

Clock and Data Edge Options

The Clock Edge option defines which edge of the clock input is used to calculate the statistics of clock based measurements. The Data Edge defines which edge of the data input is used to calculate the statistics on clock-data based measurements.

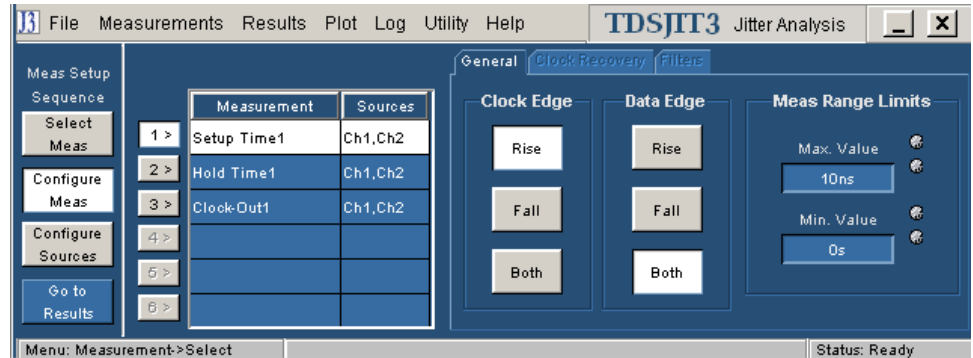

Figure 16: Clock and Data edge options

From Edge and To Edge Options

The From Edge option defines which edge on the first waveform is used to take the measurement. The To Edge option defines which edge on the second waveform is used to take the measurement, the same edge or the opposite edge as the first waveform.

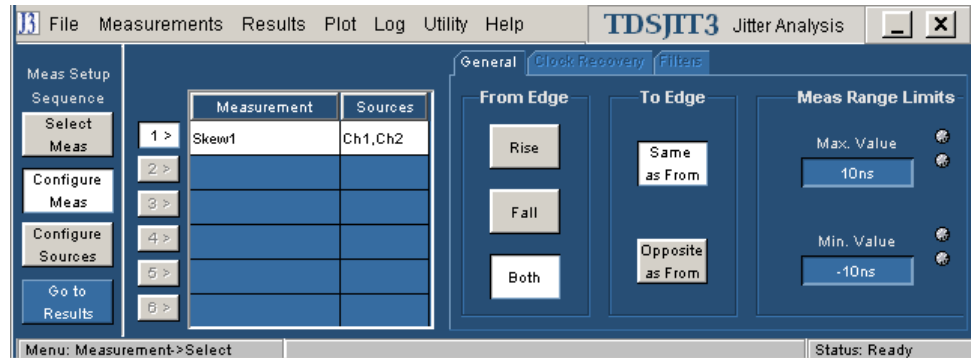

Figure 17: From Edge and To Edge options

Main Edge Options

The Main Edge option defines which edge on the Main waveform is used to take the measurement.

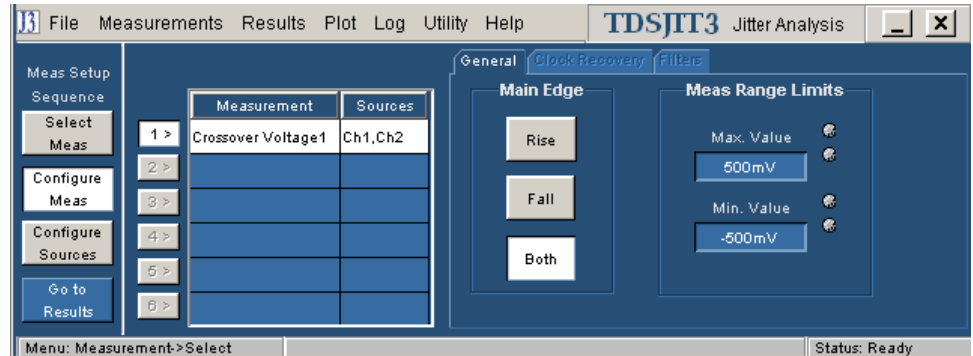

Figure 18: Main edge options

Measurement Range Limits Configuration

For two-channel measurements, you can specify the minimum and maximum range of valid measurement values. Individual measurements falling outside the selected range are discarded.

The default values for the Meas Range Limits options vary by measurement.

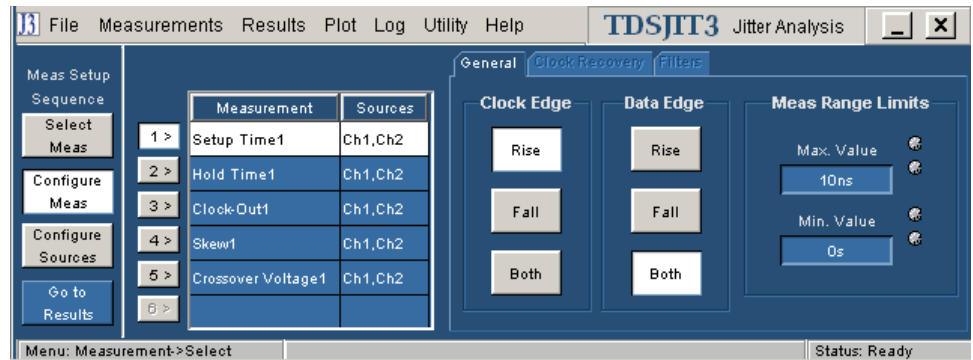

Figure 19: Meas Range Limits options

N-Cycle Measurement Configuration

You can define a Clock Edge and some unique General Configuration options for the N-Cycle measurement.

Table 10: N-Cycle measurement configuration

Option	Description
Clock Edge	Waveform edge used to calculate statistics
N=	Number of cycles in an N-cycle group
1 st Meas: Start @ Edge	Number of cycles skipped prior to starting the measurement
Edge Increment	Specifies how consecutive measurements (each spanning 2 N-cycles) jump forward
1	By one cycle in the waveform
N	By N cycles in the waveform

N-Cycle Measurement Options

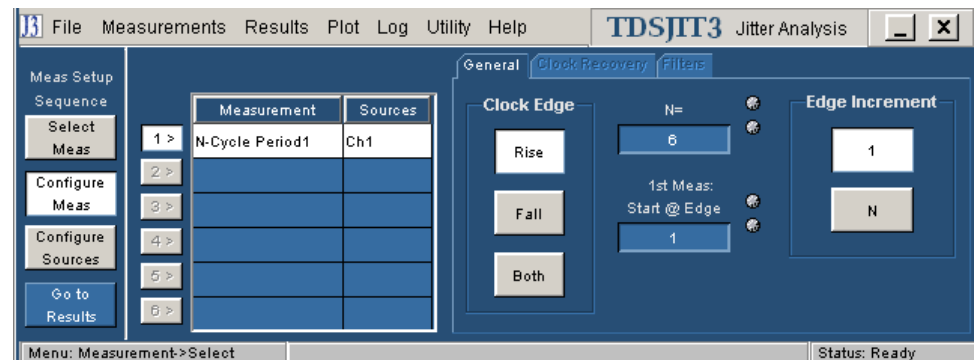

Figure 20: N-Cycle measurement options

Clock-Data-TIE Measurement Configuration

You can define a Clock Edge and define Clock Delay Time to delay clock edges for this measurement in order to adjust its alignment with data edges or to take into account for transport delay. The Clock Delay Time configuration does not affect other measurements. You can also setup Rj/Dj separation for this measurement.

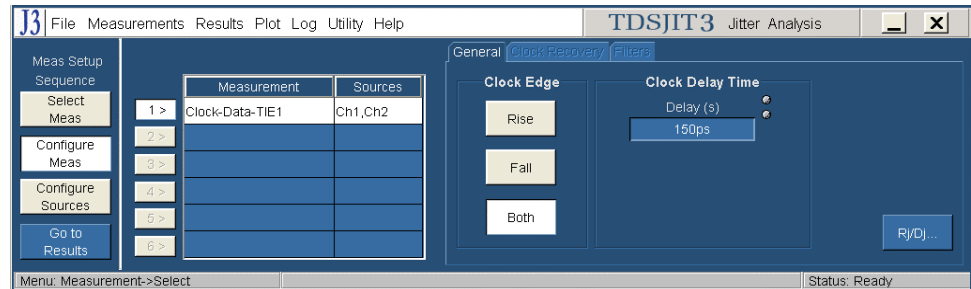

Figure 21: Clock-Data-TIE measurement configuration

TIE Rj/Dj

Rj/Dj analysis refers to the process of separating jitter into the major categories of Random Jitter (Rj) and Deterministic Jitter (Dj), and further separating Dj into specific subcomponents based on observable properties of the jitter. This can help you understand and reduce the jitter in your circuit. For serial data signals with embedded clocks, it also allows you to accurately predict the eye opening and total jitter at very low bit error rates, in a few seconds. By contrast, direct measurement of these quantities can take hours for a single eye-opening measurement.

For data signals, there are two methods of Rj/Dj analysis provided in the application. The Rj/Dj Analysis of Repeating Patterns Using a Spectral Approach, which requires a data signal with a cyclically repeating data pattern, is a method with wide industry acceptance. The Rj/Dj Analysis of Arbitrary Patterns method uses a technique that allows jitter separation and analysis even if the data pattern is random or unknown.

Each method has advantages and limitations. For clock signals, the spectral analysis approach is automatically used.

Once an Rj/Dj analysis has been done, the results may be plotted in the form of a Bathtub Plot.

Rj/Dj Analysis of Repeating Patterns Using a Spectral Approach

This method of Rj/Dj analysis uses a Fourier transform of the time-interval error signal to identify and separate jitter components. It is described in the *Fibre Channel -- Methodologies for Jitter and Signal Quality Specification (MJSQ)*, and was the analysis method originally introduced with the TDSJIT3 application.

This method requires that the data signal be composed of a pattern of N bits that are repeated over and over. The pattern length (N) must be known, although it is not necessary to know the specific bits that make up the pattern.

When the data pattern is not repeating, or is unknown, a second method of Rj/Dj analysis may be used. (It may also be used if the pattern is repeating, and correlates well with the Spectral method in this case.) This method assumes that the effects of Intersymbol Interference (ISI) only last for a few bits. For example, in a band-limited link where a string of ones follows a string of zeros, the signal may require three or four bit periods to fully settle to the "high" state.

In this method, an analysis window with a width of K bits is slid along the waveform. For each position of the window, the time interval error of the right-most bit in the window is stored, along with the K-1 bit pattern that preceded it. After the window has been slid across all positions, it is possible to calculate the component of the jitter that is correlated with each observed K-1 bit pattern, by averaging together all the observed errors associated with that specific pattern.

In the configuration menu for the arbitrary-pattern method, the Window Length field allows you to select how many bits are included in the sliding window. The window should include enough bits to encompass the impulse response of the system under test, usually 5 to 10 bits. A good practical test is to check whether increasing the window length causes any appreciable change in the jitter results; if not, the window length is effectively capturing all the ISI effects. The disadvantage of increasing the window length is that it uses more memory and slows the processing.

The configuration menu also includes a field for selecting what population of each K-1 bit pattern must be accumulated before the TIE associated with that pattern is considered accurate. Using a larger population means that more observations are averaged together, so that the variance of the measurement is reduced. Specifying a larger population has the disadvantage of requiring a longer measurement period before results can be calculated.

It may be necessary to sequence the instrument several times before enough statistics are accumulated to provide results. A vertical gauge on the TIE:RjDj results screen provides an indication of how the accumulation is progressing.

The arbitrary-pattern approach to measuring jitter may not be appropriate if there are very-long-duration memory effects in your data link. An example would be if there is impedance mismatch reflections that arrive long enough after the initial edge to fall outside the analysis window.

Bathtub Curve and BER Versus Decision Time

The Bathtub Curve plot shows the eye opening and total jitter values as functions of the BER level. The plot is obtained from the Rj/Dj separation.

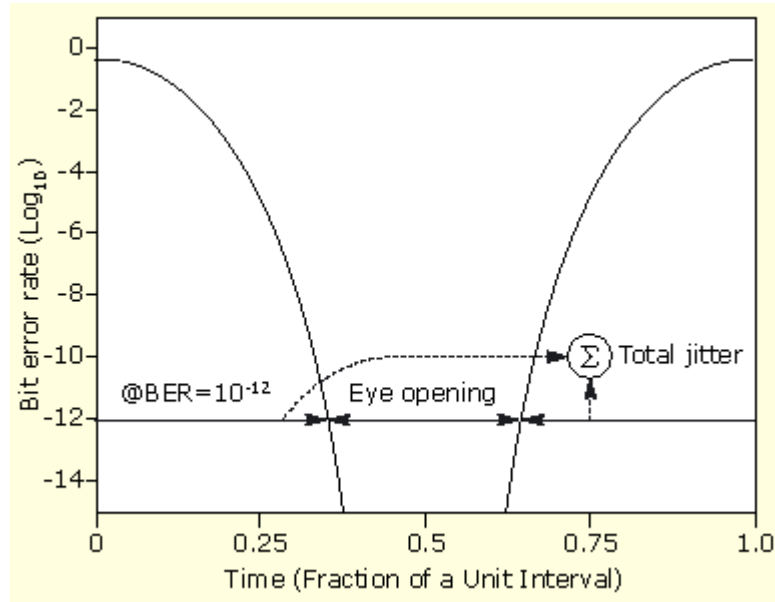

Figure 22: Bathtub Curve and BER versus Decision Time

Table 11: TIE: RjDj analysis configuration

Option	Description
Separation	Enables or disables Rj/Dj separation analysis
Total Jitter BER=1E-?	Sets the BER level for the eye opening and total jitter
Data Pattern*	
Type*	Selects a Repeating or an Arbitrary data pattern
Pattern Length*	When the Type option is set to Repeating, sets the pattern length of the repetitive pattern data; use for spectrum analysis Rj/Dj separation
Window Length*	When the Type option is set to Arbitrary, sets the pattern window length used for arbitrary pattern Rj/Dj separation
Population*	When the Type option is set to Arbitrary, sets the minimum population limit for each pattern to be qualified for arbitrary pattern Rj/Dj separation
* Available only for Data TIE and Data PLL TIE measurements.	

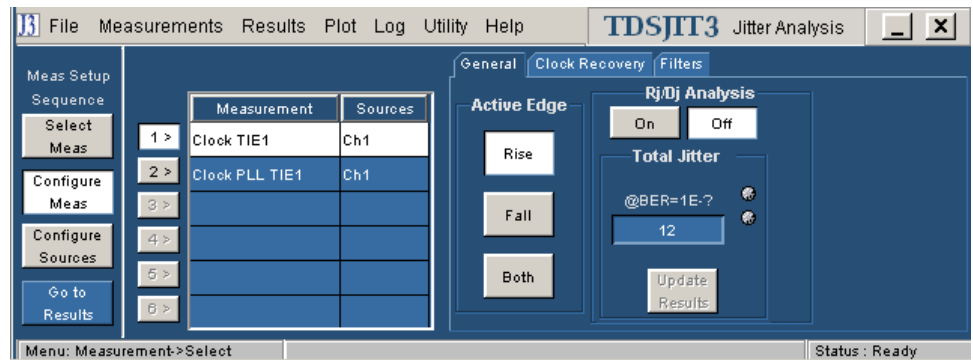

Figure 23: TIE: RjDj analysis options for Clock TIE and Clock PLL TIE

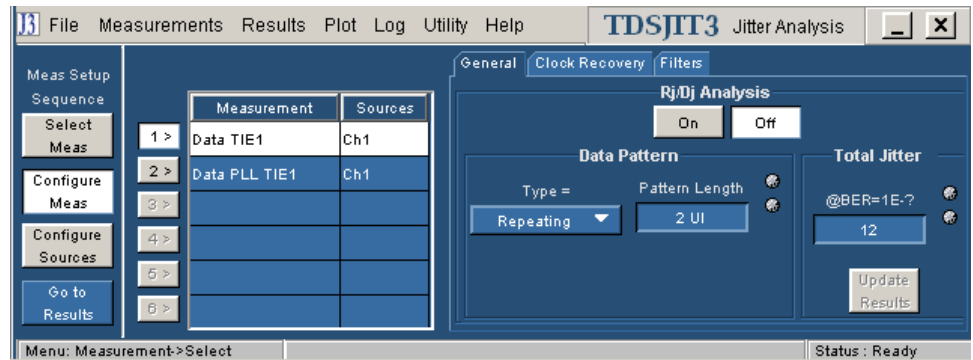

Figure 24: TIE: RjDj analysis options for Data TIE and Data PLL TIE

Clock Recovery Configuration

For waveforms that are synchronized to a nominal clock frequency, TIE measurements offer a choice of clock recovery methods. Clock recovery is defined as the way in which the TDSJIT3 v2 application determines the theoretically jitter-free clock to which the waveform will be compared.

Constant (straight line) clock recovery is implicitly chosen by selecting a Clock TIE or Data TIE measurement. Phase-Locked Loop clock recovery is chosen by selecting a Clock PLL TIE or Data PLL TIE measurement.

For Data measurements (Data Period, Data Frequency, Data TIE, and Data PLL TIE) on signals with extremely high jitter, advanced clock recovery support is offered. This support is not needed or recommended for most signals. It allows you to provide extra guidance to the clock recovery algorithm with respect to how many unit intervals are represented by each pair of clock edges. This is most useful in cases where the total jitter on a data signal exceeds 0.5 unit intervals.

In Constant Clock Recovery, the clock is assumed to be of the form $A \cdot \sin(2\pi ft + \phi)$, where the frequency (f) and phase (ϕ) are treated as unknown constants. Once a source waveform has been acquired and the edges extracted,

f and ϕ are chosen using linear regression, so that the recovered clock minimizes the mean-squared sum of the Time Interval Error (TIE) for that waveform.

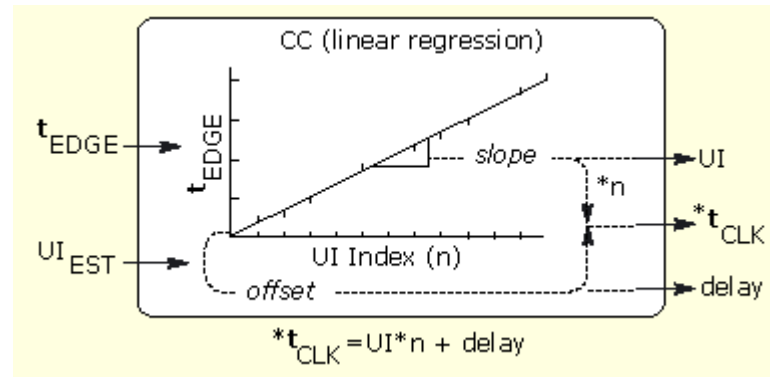

Figure 25: Constant Clock Recovery concept

Constant Clock Recovery Setup

The Ref Clock Frequency control area provides three options that control how the clock recovery is performed.

Selecting Autocalc Every Acq will allow the clock-recovery algorithm to choose a new best-fit clock frequency and phase for each new oscilloscope acquisition.

Selecting Autocalc 1st Acq will allow the clock-recovery algorithm to choose a new best-fit clock frequency and phase only on the first acquisition. Subsequent acquisitions will choose a best fit on clock phase but retain the clock frequency found on the first acquisition. Clearing the measurements by choosing Clear on the control panel will reset the clock recovery so that both frequency and phase are optimized on the subsequent acquisition.

Selecting Custom allows you to specify an exact clock frequency, so that absolutely no clock frequency optimization is performed. A best fit of the clock phase is still performed on every acquisition.

Table 12: Reference Clock Frequency configuration

Option	Description
Autocalc 1 st Acq	Calculates the best fit of the initial acquisition or the first acquisition after clearing results, and then uses the value until you clear the results
Autocalc Every Acq	Calculates the best fit for each acquisition (default)
Custom: Value	Uses the exact frequency you enter

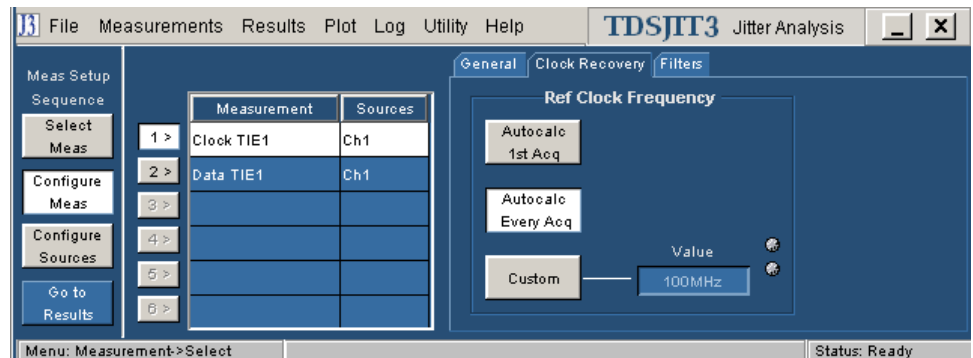

Figure 26: Reference Clock Frequency options

Phase-Locked Loop (PLL) Clock Recovery

In PLL Clock Recovery, the application simulates the behavior of a hardware phase-locked loop clock recovery circuit. This is a feedback loop in which a voltage-controlled oscillator is used to track, or follow, slow variations in the bit rate of the input waveform. Such loops are frequently used to recover the clock in communication links that do not transmit the clock as a separate signal. The PLL parameters in the application may be adjusted to mimic the behavior of a receiver in such a link, within certain guidelines.

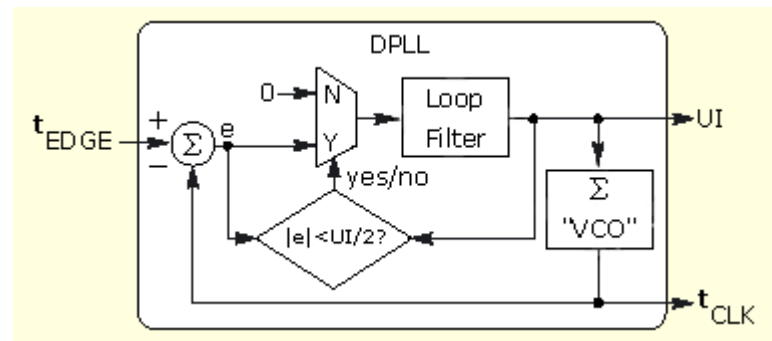

Figure 27: Phase-Locked Loop (PLL) Clock Recovery concept

PLL Clock Recovery Setup

The PLL control area provides control over the phase-locked loop used for clock recovery. You can choose the loop bandwidth and the loop order, and if a second-order loop is chosen, you can specify the damping factor.

The loop bandwidth can be selected implicitly by specifying a data communications standard, or it can be set explicitly.

To use a standards-based setup, select the Standard Frequency button. From the Standard: Speed (Gb/s) list box, choose the standard that matches your data link. For example, choose "FC2125: 2.125" to test a 2.125 Gbit/second Fibre Channel link. The PLL bandwidth will be set to 1/1667 of the baud rate.

To manually control the loop bandwidth, choose the User button and use the Value option to select the 3 dB bandwidth of the loop, in Hertz.

You can use the PLL Order list box to choose between a first-order or second-order loop. More correctly, this is the loop type, where a type 1 loop has a transfer function that approaches zero frequency with a slope of $1/s$ and a type 2 loop approaches zero frequency with a $1/s^2$ slope. The term Order is used in the application as a concession to popular usage. For a more thorough treatment of loop type and order, see *Frequency Synthesis by Phase Lock*, by William Egan.

If you choose a second-order loop, the Damping option becomes enabled. (The Damping Factor does not apply to first-order loops.)

Note: Although it is possible to configure a second-order PLL with a bandwidth up to 1/10 of the baud rate, such a loop will have poor dynamic performance. This is because second-order loops have less phase margin than first-order loops. A preferred alternative to using a second-order PLL with a high bandwidth is to use a second-order high-pass measurement filter to emulate the effects of the PLL.

Table 13: PLL Loop Bandwidth configuration

Option	Description
Standard Frequency	Select a standard: FC133:0.1328, FC266:0.2656, FC531:1.0625, FC1063:11.063, FC2125:2.125, IB2500:2.5, SerATAG1:1.5, SerATAG2:3, SerATAG3:6, USB_FS:0.12, USB_HS:0.48, 1394b_S400b:0.4915, 1394b_S800b:0.983, 1394b_S1600b:1.966, GB_Ethernet:1.25, 100BaseT:0.125, OC1:0.0518, OC3:0.155, OC12:0.622, OC48:2.488
Custom: Value	Sets the 3 dB bandwidth of the Phase Locked Loop (PLL)
PLL Order	Sets the order of the PLL
Damping	Sets the damping ratio of the PLL
Advanced*	

* Available only for Data PLL TIE measurements.

Loop BW Options

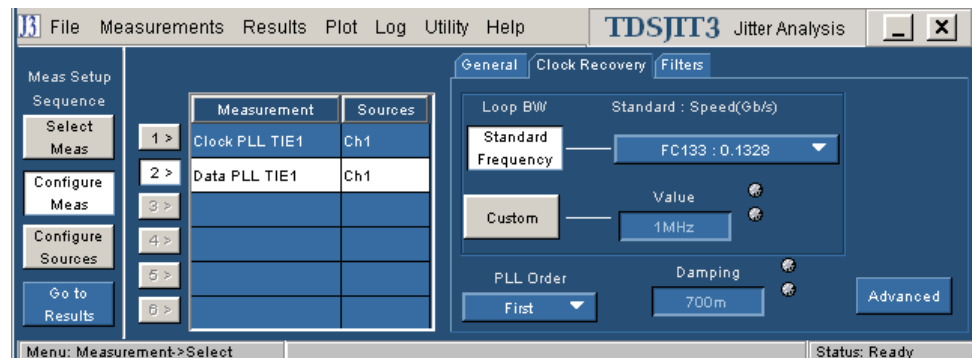

Figure 28: PLL Loop Bandwidth options

Advanced Clock Recovery Setup

For Data Period, Data Frequency, Data TIE and Data PLL TIE measurements, you may use several types of advanced clock recovery if needed. The advanced clock recovery tools can be helpful if your signal has jitter excursions that exceed 0.5 unit intervals, by guiding the application in choosing the number of unit intervals that correspond to each pair of edges. Advanced clock recovery is seldom required, and is not recommended for general analysis.

When Advanced Clock Recovery is enabled for a given source, it applies to all Data measurements using that source. For example, if you have Data Period and Data TIE measurements on Channel 1, enabling advanced clock recovery for one measurement will cause it to be enabled for the other as well.

Two types of advanced clock recovery are available. In the first, you can provide the nominal data rate to the clock recovery algorithm. Normally, the application analyzes your data and determines the nominal data rate automatically. If you know the data rate or unit interval to an accuracy of $\pm 3\%$, you can provide this information as a clue to the algorithm.

You can also provide clock recovery guidance in the form of a known data pattern. The pattern is specified by using an ASCII text file containing the characters 1 and 0. The file may contain other characters, spaces and tabs for formatting purposes, but they will be ignored. Several files for commonly-used patterns are included with the application, and you may use these as examples if you wish to create your own pattern files. The default location for pattern files is C:\TekApplications\TDSJIT3v2\patterns.

If you use pattern file guidance, the clock recovery algorithm will perform a best fit of the selected data pattern against the acquired edge sequence. It will then use the pattern file to determine the number of unit intervals that fall between each set of edges.

Note: Clock recovery using pattern match will provide erroneous results if your data has missing edges or extra edges at the defined edge threshold.

Table 14: Advanced Clock Recovery configuration

Area/option	Description
Nominal Data Rate	
On Off	Enables or disables advanced clock recovery through rate guidance
Unit Interval	Defines the nominal data rate by UI in time
Bit Rate	Defines the nominal data rate by the bit rate in frequency
Known Data Pattern	
On Off	Enables or disables advanced clock recovery through a known data pattern
Pattern File Name	Selects a file to use for the data pattern
OK button	Accepts changes and closes
Cancel button	Discards changes and closes

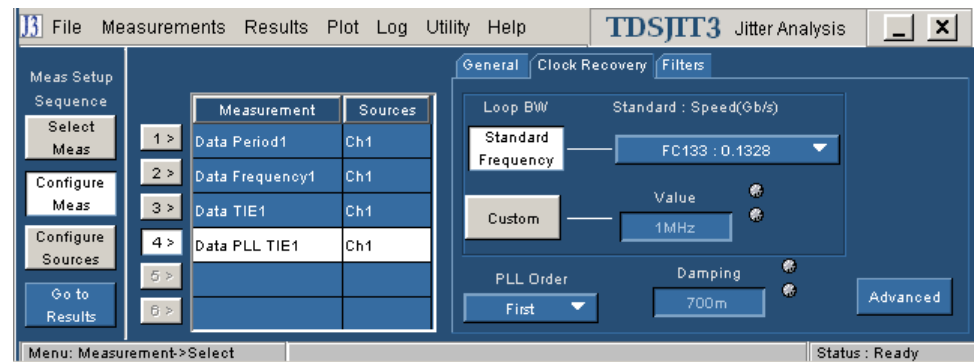

Figure 29: Advanced Clock Recovery options

Filters

For some measurements (Clock Period, Clock Frequency, Clock TIE, Clock PLL TIE, Data Period, Data Frequency, Data TIE, and Data PLL TIE), the measurements-versus-time waveform (time trend) that is derived from the original oscilloscope waveform can be filtered before it is passed to the statistics and plotting subsystems.

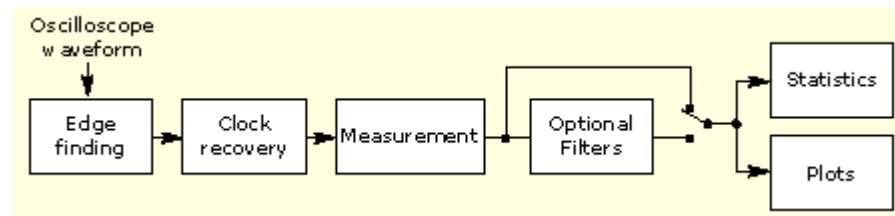

Figure 30: Optional filters

You can modify the time trend by applying filters that block specific frequency bands. You can configure a High Pass filter to block out the low frequency band or a Low Pass filter to block out the high frequency band.

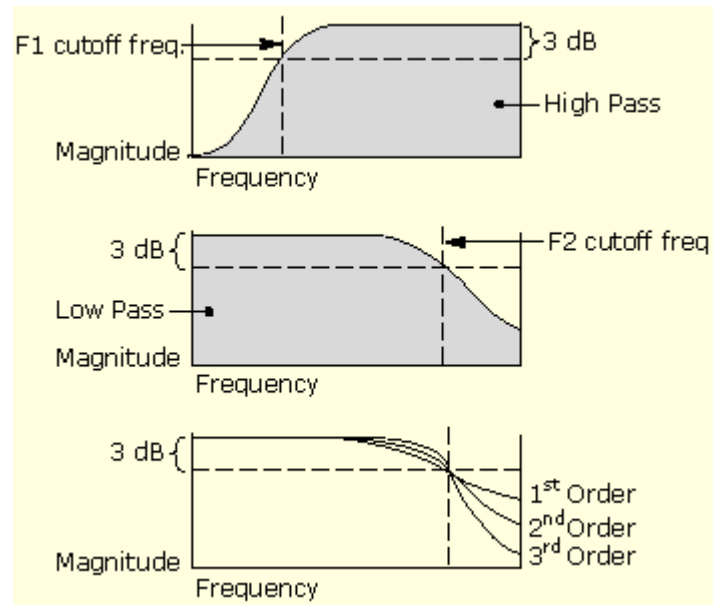

Figure 31: Filter characteristics

Band Pass Filtering

You can create a band pass filter by enabling both the High Pass and Low Pass filters on a measurement. The cutoff frequency for the Low Pass filter must be greater than or equal to the cutoff frequency for the High Pass filter.

You should be aware that setting the cutoff frequencies close to each other may effectively filter out all of the time trend, or all but a small amount of noise. This diagram shows the spectrum of the time trend passed to the statistics and plotting subsystems when you use both the High Pass and the Low Pass filters.

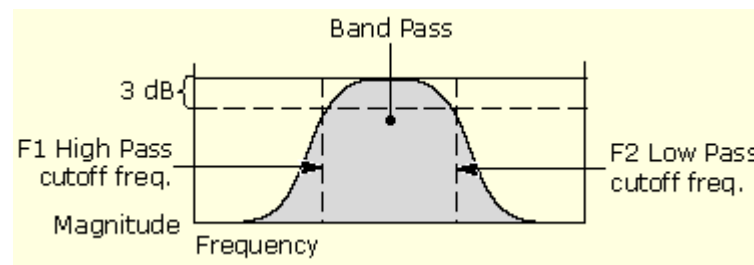

Figure 32: Band Pass filtering

Influence of High Pass Filters on Period and Frequency Statistics

High-pass filters attenuate low frequencies, and filter out DC values entirely. When a high-pass filter is added to a period or frequency measurement, the mean value of the filtered measurement goes to zero. This can be seen by creating a Time Trend plot of a high-pass-filtered period or frequency measurement. Although this is the correct theoretical behavior for the filtered measurement, it is not very useful if the Results panel reports that the mean period or frequency is zero. For this reason, the mean values that appear in the results panels for Period and Frequency measurements are the values prior to the filter.

Table 15: Filters configuration

Option	Description
High Pass	
Filter Spec	When enabled, blocks the low frequency band and passes on only the high frequency band of the waveform; defined as 1 st order, 2 nd order, or 3 rd order Butterworth
Freq (F1)*	High Pass filter cutoff frequency; frequency at which the filter magnitude has dropped by 3 dB
Low Pass	
Filter Spec	When enabled, blocks the high frequency band and passes on only the low frequency band of the waveform; defined as 1 st order, 2 nd order, or 3 rd order Butterworth
Freq (F2)*	Low Pass filter cutoff frequency; frequency at which the filter magnitude has dropped by 3 dB

* Includes a 3 dB attenuation.

These options are also available for Data measurements.

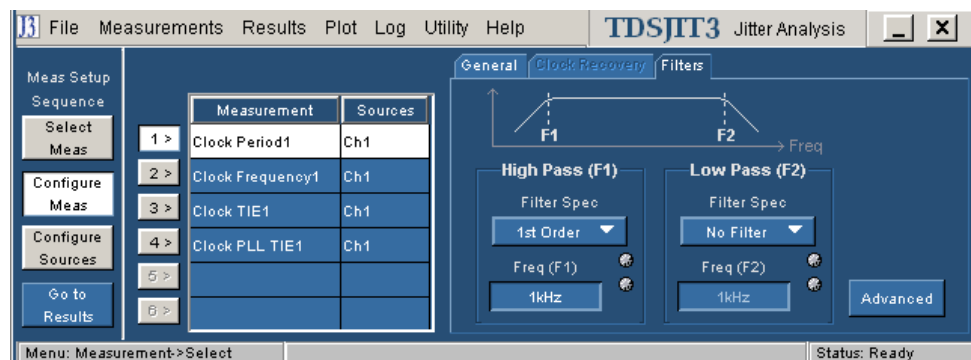

Figure 33: Filters options

Advanced Filter Configuration

The measurement filters are implemented using infinite impulse response (IIR) designs. As with any causal filter, a transient may occur at the filter’s output in response to the arrival of the input signal. It is usually desirable to exclude this transient from the measurement results.

In the TDSJIT3 v2 application, the filter transient is managed by specifying a settling time, Td. A smoothing window ramps the filter input from 0 to 1 during this settling time. The output of the filter during the settling time is excluded from the measurement results. The smoothing window has a raised-cosine profile which is described by:

$$W(t) = \frac{1}{2} \left[1 - \cos\left(\frac{\pi \cdot t}{T_d}\right) \right] \text{ for } 0 \leq t < T_d$$

where the settling time of the filter (Td) is configurable. The operation of the smoothing window is shown graphically in the Effect of the Smoothing Window topic.

By default, the settling time is set to 2/Fc, where Fc is the lowest filter cut-off frequency applied to the measurement.

Note: Setting the settling time to less than 1/Fc increases the chance that the measurement results will include effects that are due to the filter transient. The user interface will warn you if you configure the measurement this way.

Table 16: Advanced Filter configuration

Option	Description
Duration	Defines the amount of time excluded from the measurement results to allow the filter to settle
OK button	Accepts changes and closes

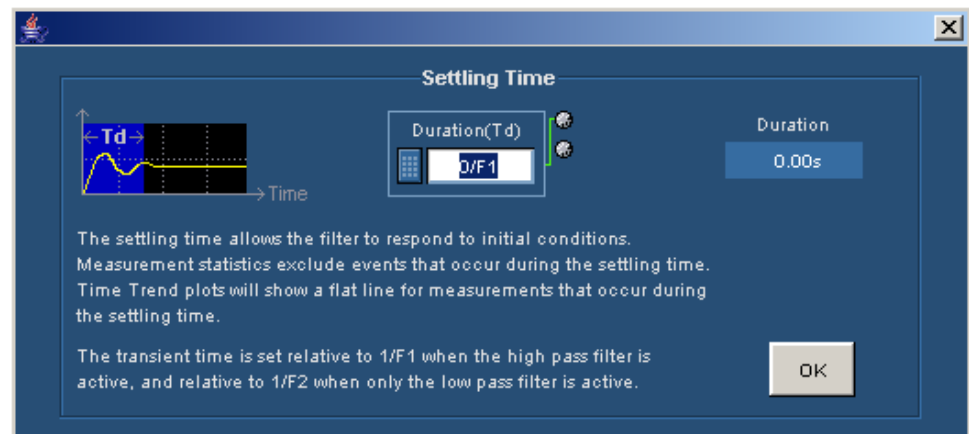

Figure 34: Advanced Filter options

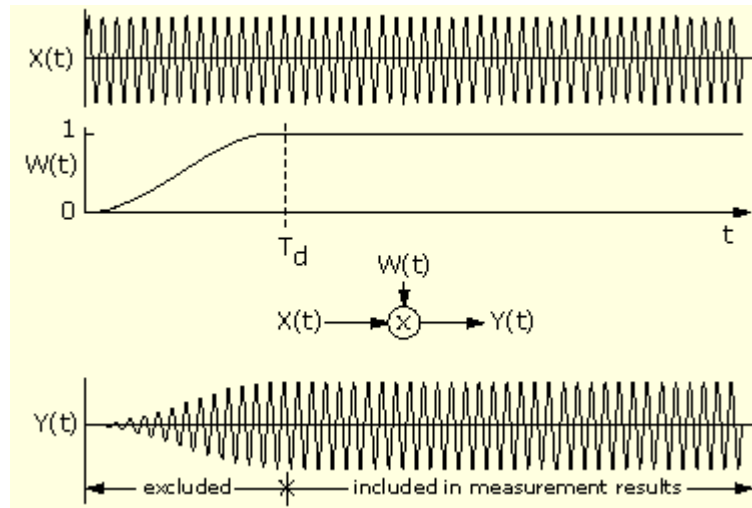

Figure 35: Effect of the Smoothing window

Configuring Sources

You may configure the sources associated with your measurements, which can be as simple as using the Autoset features that automatically calculate the scale or the reference voltage levels.

You can always access the menus by selecting **Measurements > Source** in the

menu bar. In addition, you can use the **Configure Source** button (when visible) as a short cut to the Configure Measurements menus.

The application includes the following Configure Source menus:

- Autoset
- Gate/Qualify
- Ref Levels
- Stat Pop Limit

Table 17: Configure Sources menus

Menu name	Description
Sources Autoset*	Automatically changes the vertical scale or horizontal resolution of the measurement source waveforms Autoset acts on all active (Ch1, Ch2, Ch3, Ch4) sources used by measurements directly or contained in a math source definition Accurate measurement results require sufficient vertical and horizontal resolution
Gate/Qualify*	Gating limits measurements to an area of the source waveform bounded on the left and right by vertical cursors or by the lowest zoom that is on Qualify limits measurements to the one or more areas of the waveform where a qualifier waveform is active
Ref Levels	Specifies reference voltage levels for each measurement source; separate reference levels apply to rising and falling edges
Stat Pop Limit**	Sets the maximum population of all measurements; Free Run sequencing mode will stop when all measurements have attained this limit
* All sources must have the same Horizontal Sample Rate, Record Length, and Position to assure that measurements function properly.	
** In Free Run mode, sequencing stops when all the population limits are met.	

Autosetting Sources for Live (Channel) Waveforms

In most situations, you can improve accuracy on channel or math waveform by using the Source Autoset options to optimize the vertical scale or horizontal resolution settings of the oscilloscope.

The Vertical Scale option automatically checks the Peak-to-Peak level of live sources. The vertical scale and offset of all signals with a Peak-to-Peak less than six divisions is adjusted so the Peak-to-Peak will be eight divisions. If the maximum or minimum value of a signal is "clipped," the vertical scale and offset is adjusted so the Peak-to-Peak will be 8 divisions.

The Horizontal Resolution option automatically checks the number of samples/edge on the rising and falling transitions (Rise Time/Resolution and Fall Time/Resolution) of all live channels. The oscilloscope horizontal resolution is set to the largest value that does not cause the samples/edge of the fastest edge to fall below the specified target. The target is five samples per edge when optimized for edge resolution, and 2.5 samples per edge when optimized for edge count. Horizontal Resolution sets the acquisition sampling mode to Interpolated Real Time for signals with very high edge speeds. The default record length is 500 k points.

To automatically define both the vertical and horizontal settings for all channel sources, select the All button. The All option also applies an oscilloscope Autoset on each channel prior to performing the vertical scale and horizontal resolution autoset.

To automatically define the vertical or horizontal settings for active sources, follow these steps:

1. Ensure that any channel waveform that you want to autoset is visible on the oscilloscope.
2. If you intend to select the All or Horizontal Resolution button, configure the Optimize Horizontal For option to one of the following:
 - Edge Resolution: results in five samples per edge or more, giving you better edge timing and measurement accuracy.
 - High Edge Count: results in as few as 2.5 samples per edge. Some edge timing accuracy is sacrificed for more edges in a given record length. High edge count is desirable for RjDj analysis in oscilloscopes without extended record lengths.
3. Select one of the following options:
 - All button to Autoset both vertical and horizontal setting
 - Vertical Scale button to Autoset oscilloscope vertical settings only
 - Horizontal Resolution button to Autoset oscilloscope horizontal settings only

Optionally, select the Undo button to return the oscilloscope to its state prior to autoset.

Note: At rise times less than 100 ps, the application may have only two actual sample points per edge to work with. The application will set up a suitable level of oscilloscope acquisition interpolation to increase the point count per edge to around five points.

Table 18: Configure Sources Autoset configuration

Option	Description
All	Performs a sequence: oscilloscope AUTOSSET, Vertical Scale, and Horizontal Resolution
Vertical Scale	If a channel waveform does not exceed six vertical divisions, decreases the scale so the waveform occupies about eight divisions
Horizontal Resolution	Sets the horizontal resolution so that the number of samples on the fastest transition (edge) exceeds a specified target; see Optimize Horizontal For option
Undo	Returns to the settings present before an Autoset was performed; disabled after measurements are taken until you perform another Source Autoset

Table 19: Optimize Horizontal For configuration

Area/option	Description
Optimize Horizontal For	
Edge Resolution	Sets the horizontal scale to ≥ 5 samples per transition; edge timing accuracy does not improve significantly at higher resolution Edge timing accuracy will not significantly improve at higher resolution (default)
Max Edge Count	Sets the horizontal scale to ≥ 2.5 samples per transition; Rj/Dj analysis requires a larger data set If the oscilloscope does not have a long acquisition memory, it may be necessary to trade some Edge timing accuracy for a larger data set

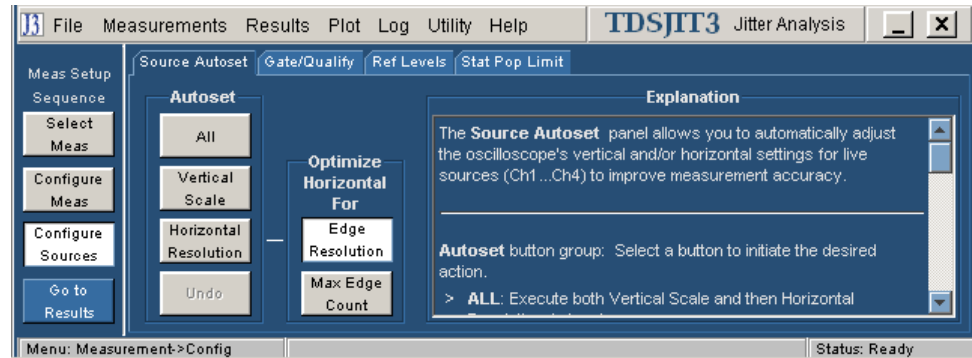

Figure 36: Configure Sources Autoset options

Gate/Qualify

Gating allows you to limit the analysis to a specific area of the waveform bounded by cursors or zoom limits, thereby excluding unnecessary information. To access the Gating menu, select Measurements> Configure Source> Source Gate/Qualify. View the Configure Sources Gate/Qualify menu.

You can set up a gated region in one of the following ways:

- Zoom
- Cursors (vertical)

Qualifiers allow you to limit the application to more narrowly defined conditions before taking measurements. This is another way to exclude unnecessary information. All sources for the measurements and Qualify input must have the same Horizontal Sample Rate, Record Length, and Position to ensure that measurements function properly. For TIE and PLL TIE measurements, only the first qualified region will be measured even if multiple qualified regions are present.

Table 20: Configure Sources Gating configuration

Option	Description
Off	No gating occurs; application takes measurements over the entire waveform
Zoom	Zoom to a specified region of the source waveform and take measurements within the selected area
Cursors	Use oscilloscope cursors to define a specific part of the waveform and take measurements within the selected area

Configure Sources Gate/Qualify Menu

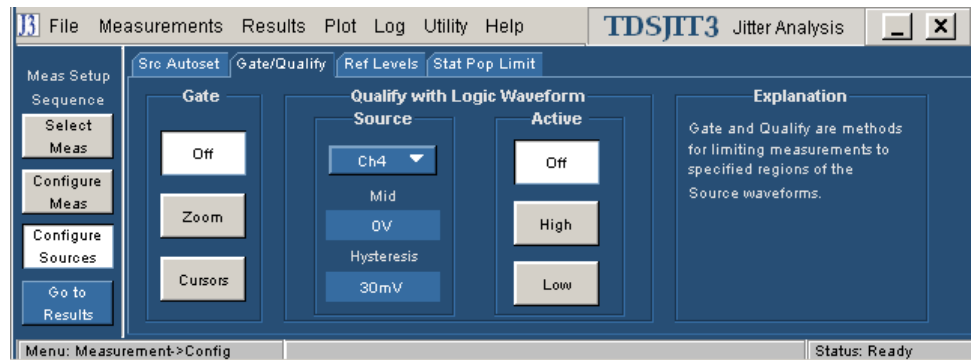

Figure 37: Configure Sources Gating options

Table 21: Configure Sources Qualify configuration

Option	Description
Source*	Selects a waveform to qualify the signal or clock source used for the measurement
Mid	Shows the vertical reference level of the qualifier waveform
Hysteresis	Shows the vertical reference margin of the qualifier waveform
Active	
Off	Disables the use of the qualify waveform
High	Enables measurements in regions** where the qualifier waveform exceeds the mid reference level
Low	Enables measurements in regions** where the qualifier waveform falls below the mid reference level
* Measurement and Qualify sources must have the same Horizontal Sample Rate, Record Length, and Position to ensure that measurements function properly.	
** For TIE and PLL TIE measurements, only the first qualified region will be measured even if multiple qualified regions are present.	

Ref Levels

Timing measurements are based on state transition times. By definition, edges occur when a waveform crosses specified reference voltage levels. Reference voltage levels must be set so that the application can identify state transitions on a waveform. By default, the application automatically chooses reference voltage levels when necessary.

The TDSJIT3 v2 application uses three basic reference levels: High, Mid and Low. In addition, a hysteresis value defines a voltage band that prevents a noisy waveform from producing spurious edges. The reference levels and hysteresis are independently set for each source waveform, and are specified separately for rising versus falling transitions.

There are two ways to set the reference voltage levels: automatically or manually.

High, Mid and Low Reference Voltage Levels

The application uses three reference voltage levels: High, Mid, and Low.

- For most measurements, the application only uses the Mid reference voltage level. The Mid reference level defines when the waveform state transition occurs at a given threshold.
- For Rise Time and Fall Time measurements, the High and Low reference voltage levels define when the waveform is fully high or low.

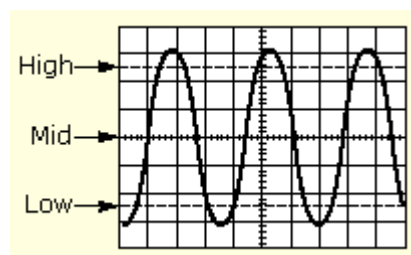

Figure 38: Reference voltage levels diagram

Rising Versus Falling Thresholds

You can specify thresholds for each of the reference voltage levels: High, Mid, and Low. The application uses the thresholds to determine the following events:

- A Low/Mid/High rising event, which occurs when the waveform passes through the corresponding Rise threshold in the positive direction.
- A Low/Mid/High falling event, which occurs when the waveform passes through the corresponding Fall threshold in the negative direction.

For a given logical reference level (such as Low, Mid, or High), rising and falling events alternate as time progresses.

Note: In many cases, the rising and falling thresholds for a given reference voltage level are set to the same value. In those cases, a hysteresis value helps prevent spurious edges produced by small amounts of noise in a waveform.

Using the Hysteresis Option

The hysteresis option can prevent small amounts of noise in a waveform from producing multiple threshold crossings. You can use a hysteresis when the rising and falling thresholds for a given reference voltage level are set to the same value.

The reference voltage level \pm the hysteresis value defines a voltage range that must be fully crossed by the waveform for an edge event to occur. If the decision threshold is crossed more than once before the waveform exits the hysteresis band, the mean value of the first and last crossing are used as the edge event time.

For example, if the waveform rises through the Threshold - Hysteresis, then rises through the Threshold, then falls through the Threshold, then rises through both the Threshold and the Threshold + Hysteresis, a single edge event occurs at the mean value of the two rising crossings.

Example of Hysteresis on a Noisy Waveform

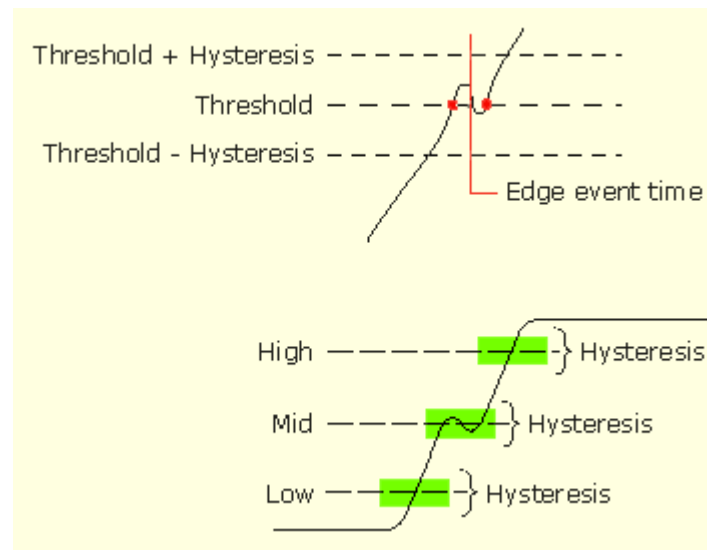

Figure 39: Example of Hysteresis on a noisy waveform

Automatic Versus Manual Reference Voltage Levels

Each measurement source may be configured to automatically choose voltage reference levels (default), or to lock the reference voltages to levels of your choosing.

In the Ref Levels configuration panel, a table at the left edge contains all of the currently active measurement sources. An Autoset checkbox appears beside each source. To enable or disable Autoset for a given source, choose the source button in the left column and select the corresponding checkbox to toggle its state.

To learn more about automatically or manually setting voltage reference levels, refer to Understanding When Ref Level Autoset will Occur and Understanding How Ref Level Autoset Chooses Voltages.

Table 22: Configure Sources Ref Levels Autoset configuration

Option/button	Description
Autoset	Identifies which sources on which to perform an autoset; you can set or clear the option for each source
Update*	Immediately calculates and displays the reference voltage levels for all sources where the Autoset option is set according to the Autoset Ref Level Setup menu
Setup	Specifies the Base-Top method and relative percent to be used for all reference voltage levels when an autoset occurs
*If you do not select this button, the application updates the reference levels (if needed) when you select the Single or Run/Stop button to take measurements.	

Understanding When Ref Level Autoset will Occur

When Autoset is enabled for a given source, the individual reference levels are displayed but you may not manually adjust them. Instead, the reference levels are automatically recalculated whenever one of the following events occurs:

- A measurement sequence is initiated for the first time after a source has become active
- A measurement sequence is initiated for the first time after all results have been cleared
- The "Update" button at the right edge of the panel is pressed

The Update button is provided as a convenience, but it is never required. Autoset will always be run (if enabled) before an uninitialized source is used for a measurement.

An "Armed" indicator appears in the upper right corner of the panel whenever a new source has been added or measurement results have been cleared. This lets you know that the reference levels will be recalculated the next time either the Single or Run/Stop button is selected. If the "Armed" indicator is not visible, the displayed reference levels will be retained if a measurement sequence is performed with no further configuration changes. You can cause the reference levels to be recalculated at any time by selecting the Update button.

Understanding How Ref Level Autoset Chooses Voltages

Once triggered, the Reference Level Autoset function uses the following logic to determine actual voltage levels.

For each applicable source, the **Top** (high logic level) and **Base** (low logic level) are first determined. Then, the High, Mid and Low levels are calculated as percentages of the Top-Base difference. For example, if the Top and Base were 2.8 volts and 0.4 volts respectively and the High percentage level was 90%, this threshold would be calculated as:

$$HighThresh = Base + HighPercent \cdot (Top - Base) = 0.4 + 0.9 \cdot (2.8 - 0.4) = 2.56$$

You can select the method used for calculating the Top and Base of the waveform, as well as the percentages used for the High, Mid and Low thresholds, for each source. To do so, see the Configure Source Ref Levels Autoset Options topic.

Table 23: Configure Sources Ref Levels Autoset configuration

Area/option	Description
Base-Top Method	
Min-Max	Uses the minimum and maximum values in the waveform to determine the base-top amplitude Useful on a waveform with low noise and free from excessive overshoot
Low-High (Histogram)	Uses a histogram approach to determine the base-top amplitude Creates a histogram of the amplitudes of the waveform; the histogram should have a peak at the nominal high level, and another peak at the nominal low level
Auto	Automatically determines the best Base-Top Method to use
Set Ref Level % Relative to Base-Top*	
Rise High	Sets the high threshold level for the rising edge of the source
Rise Mid	Sets the middle threshold level for the rising edge of the source
Rise Low	Sets the low threshold level for the rising edge of the source
Fall High	Sets the high threshold level for the falling edge of the source
Fall Mid	Sets the middle threshold level for the falling edge of the source
Fall Low	Sets the low threshold level for the falling edge of the source
Hysteresis	Sets the threshold margin to the reference level which the voltage must cross to be recognized as changing; the margin is the relative reference level plus or minus half the hysteresis; use to filter spurious events
* Default settings are 90% (High), 50% (Mid), 10% (Low), and 3% (Hysteresis).	

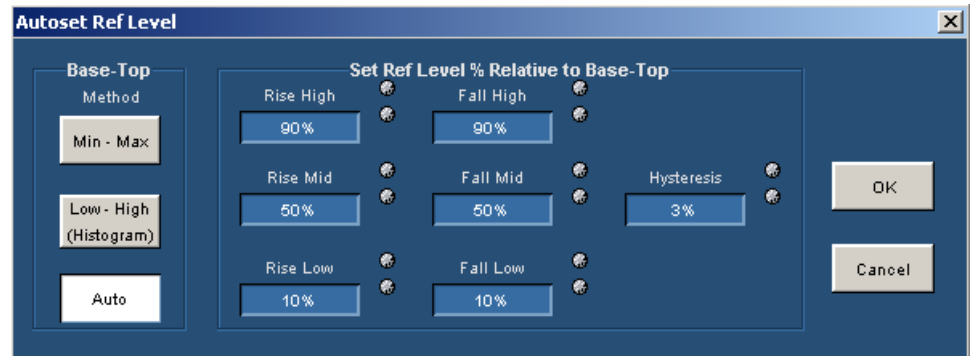

Figure 40: Autoset Ref Levels options

Manually Adjusting the Reference Voltage Levels

Whether or not you use the application to automatically calculate the initial reference voltage levels, you may need to manually change the values. To set the reference levels manually, follow these steps:

1. Select Measurements> Configure Sources> Ref Levels.
2. Select the desired source from the Source column.

Note: You cannot select sources that are not currently active.

3. Clear the Autoset option for the source you wish to set manually.
4. Select the reference levels or hysteresis options and manually adjust the values. The values will not change when you select the Update button or take measurements.

Once an active source has been set to Manual, the reference levels for that source will not change when you select the Update button or take measurements.

Note: A source will become inactive if all measurements on that source are removed. If a new measurement is then added on that source, the source once again becomes active, and defaults to Autoset. If you clear all measurements on a source that was set to Manual, you must re-select the Manual state (if desired) when the source is again added.

Table 24: Configure Sources Ref Levels configuration

Area/option	Description
Autoset (Source)	
Set (enabled)	Allows the application to automatically calculate reference voltage levels when necessary The calculation occurs when you select the Single or the Run/Stop button to start sequencing after a change to the configuration or when you select the Update button
Clear (disabled)	Prevents the application from changing the reference voltage levels from the values you set
Autoset	
Armed	Visible only when an Autoset will occur on the next measurement sequence
Update*	Immediately calculates and displays the reference voltage levels for all sources where the Autoset option is set
Setup	Displays the Autoset Ref Level menu where you can adjust the relative percent values or select a Base-Top method
Reference Level**	
Rise High	Sets the high threshold level on the slope in volts for the rising edge of the source
Rise Mid	Sets the middle threshold level on the slope in volts for the rising edge of the source
Rise Low	Sets the low threshold level on the slope in volts for the rising edge of the source
Fall High	Sets the high threshold level on the slope in volts for the falling edge of the source
Fall Mid	Sets the middle threshold level on the slope in volts for the falling edge of the source
Fall Low	Sets the low threshold level on the slope in volts for the falling edge of the source
Hysteresis	Sets the threshold margin relative to the reference level which the voltage must cross to be recognized as changing; the margin is the reference voltage level plus or minus half the hysteresis; use to filter out spurious events
*If you do not select this button, the application updates the reference levels (if needed) when you select the Single or Run/Stop button to take measurements.	
** Default settings are 90% (High), 50% (Mid), 10% (Low), and 3% (Hysteresis)	

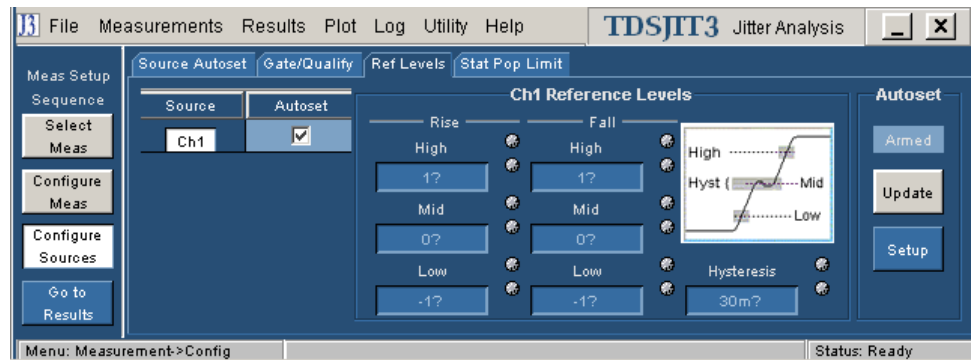

Figure 41: Configure Sources Ref Levels options

Stat Pop Limit

The Population control allows you to limit the amount of waveform data that is analyzed. You can use the Configure Source Stat Pop Limit menu to set a limit on a maximum population to obtain for all selected measurements. View the Configure Source Statistics Population Limit menu.

To define the maximum population for measurements, follow these steps:

1. Select Measurements> Configure Source> Stat Pop Limit > On.
2. Specify a value for the Size option from one to one million.

If you use a population limit, statistics individually accumulate for each measurement until the population limit is reached. A Free Run stops sequencing when all active measurements reach the population limit. A Single Run stops sequencing when the limit is less than the normal population for that Single Run.

Note: Statistics stop accumulating for an individual measurement when it reaches an internal limit of two billion. The application stops sequencing when all selected measurements have reached this internal limit.

Table 25: Configure Sources Stat pop Limit configuration

Option	Description
On	Enables or disables the application from using a population limit while taking measurements
Off	
Size	Specifies the maximum population to obtain for each active measurement

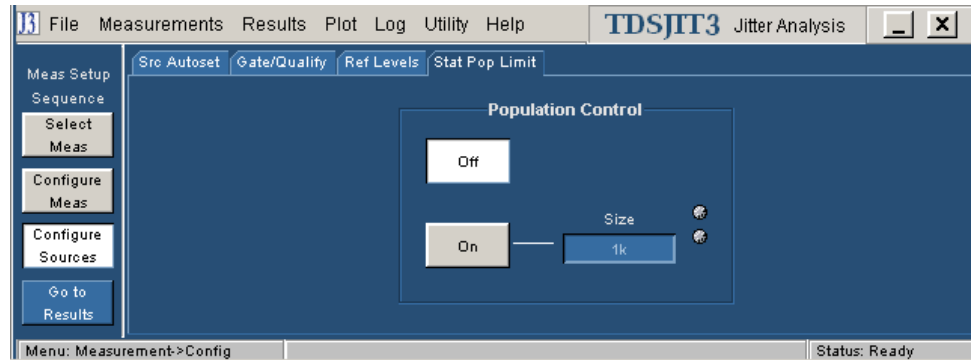

Figure 42: Configure Sources Stat pop Limit options

Measurement Summaries

You can view various summary menus that show measurement settings.

Table 26: Measurement Summaries menus

Menu name	Description
Measurement	Shows the names of each selected measurement, the waveform sources for each measurement, and the configuration parameters for each measurement
Source Ref Levels	Shows the reference voltage levels for the high, mid, and low thresholds for the rising edge and for the falling edge of each active source, plus the hysteresis
Miscellaneous	Shows if Gating, Qualify, and Stat Pop Limit functions are enabled; if enabled, also shows the Source for qualification the Size for population, and various other configuration choices.

Taking Measurements

If you want to change trigger settings or localize the measurement, you should do so before you take any measurements.

Note: If an error message displays because there are not enough cycles from which to take a measurement, adjust the Horizontal setting on the oscilloscope to increase cycles.

Note: If you select a reference waveform as the source, you need to recall and display the waveform on the oscilloscope before the application can take a measurement. To do so, refer to recalling a waveform file.

Localizing Measurements

By specifying the trigger position, the starting point, and the length of the waveform, you can effectively exclude information that is not useful to analyze before taking a measurement.



To limit the application measurement to a part of the waveform, you can use the Configure Source Gate/Qualify menu. You can also adjust the Record Length, Scale, or pre-trigger information in the oscilloscope Horizontal menu, or the Trigger Level and Slope in the oscilloscope Trigger menu.

About Sequencing

You use the Control Panel to start or stop the sequence of processes for the application and oscilloscope to acquire information from a waveform. The application then determines if the algorithm for the selected measurement can be applied to the waveform information. Sequencing is the steps to acquire waveform information, determine if the information is usable for the measurement, take the measurement, and display the results (and plots if selected).

Acquiring Data

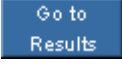
To acquire data from waveforms and take measurements, follow these steps:

1. If the Control Panel is not displayed, select the  button or select any menu from the Results drop down list.
2. Select the  Run/Stop button for continuous acquisitions. This is called the Free Run mode.

Select the  Single button for a single acquisition. The application displays the results when the sequencing is complete.

Note: If none of the selected measurements is a live source (or a Math expression which includes a live source), Free Run mode will stop after a single sequence since there is no point in repeatedly analyzing the same data.

To stop sequencing, do one of the following:



- If you wish to stop a Single measurement sequence before it is complete, select the Single button a second time. This may be useful if you have started a sequence on a long waveform and then realize you would like to change the configuration.
- If you wish to interrupt a Free Run as quickly as possible, select Run/Stop a second time. Sequencing will be halted as quickly as practical but the final measurement cycle may include results from only part of a waveform.
- If you wish to halt a Free Run cleanly, select the Single button. This will convert the Free Run mode to Single mode, so that the sequencer stops when the latest measurement cycle is complete. This is the preferred method since all accumulated measurement results will include the same number of complete measurement cycles.

Note: The status bar at the bottom of the Control Panel indicates the current sequencer state. It displays Sequencing when either Single or Free Run measurements are in process. The status bar indicates Ready when the sequencing is complete. It may also indicate Stopping when a measurement cycle has been interrupted, prior to indicating Ready.

 **Tip** Use the  command button to delete all measurement results.

New Acquisition Function of the Single Button

You may wish to perform additional measurements on the current waveform(s) rather than acquiring new waveforms. For example, you may wish to make more than six measurements on a single waveform. Or you may decide after performing a measurement cycle that you would like to perform a slightly different measurement on the same data. To do this, follow these steps:

1. Take the first measurements using the  Single button.
2. Select the  button to change the New Acq setting from Yes to No.
3. Select and configure the next set of measurements and press the Single button again.
4. When you are ready to acquire new data, select the New Acq button again to change the setting to Yes.

Note: If Run/Stop is selected while the New Acq button is set to No, the application will change the button to Yes and Free Run will proceed.

Control Panel Functions

Table 27: Control Panel functions

Command button	Description
Run/Stop (Free Run)*	Continuously acquires waveforms and sequences until you select the Run/Stop or Single command button again
Single	Acquires a new waveform if the source is Ch1, Ch2, Ch3, or Ch4; for all sources, the application sequences until complete and displays the results (and plots if selected)
New Acq = No	Without acquiring new data, calculates the statistical results for the selected measurements and displays the results (and plots if selected)
Clear	Clears all previous information in the Results menus and Plot windows; data saved to files remains intact (.csv, .wfm, etc.)
*Stops when the sequencing reaches the population limit; plots also display (if selected) when you select Stop.	



Figure 43: Control Panel options

There are two ways to view the results after an analysis is complete: as statistical values or as graphical plots.

If you set up plots before taking measurements, the application shows the selected plots in a separate window in the oscilloscope part of the display. The application shows statistics in the application part of the display. Each selected plot appears in its own window, which initially occupies the upper half of the display in front of the oscilloscope waveform.

You can also log the measurement data and measurement statistics to .csv files for viewing in a spreadsheet, database, text editor or data analysis program.

Clearing Results

Before taking more measurements, you may want to clear the results. To do so, select the  command button in the Control Panel. Clearing the results does not clear log files.

Note: Measurement log files will be overwritten with new data and results the next time you select the Run/Stop or Single buttons to take measurements.

Results as Statistics

Table 28: Statistics menus

Statistics menu	Description
All	For each individually selected measurement, shows numeric values for the population, mean, standard deviation, maximum, minimum, peak-to-peak, positive deviation, and negative deviation characteristics; two sets of values display results for the current acquisition and for all acquisitions
Min/Max	For all selected measurements, shows the sources and numeric values for the population, maximum, minimum, positive deviation, and negative deviation characteristics; you can display values for the current acquisition or for all acquisitions
Mean/Std Dev	For all selected measurements, shows the sources and numeric values for the population, mean, and standard deviation characteristics; you can display values for the current acquisition or for all acquisitions
TIE: RjDj – BER*	For selected TIE measurements, shows the jitter decomposition and the eye opening at the selected BER; two sets of values display results for the current acquisition and for all acquisitions
Equivalent RjDj***	For selected TIE measurements, shows the jitter values according to the equivalent jitter model as defined in the <i>Fibre Channel - Methodologies for Jitter and Signal Quality Specification - MJSQ</i> document; two sets of values display results for the current acquisition and for all acquisitions
* TDSJIT3 v2 Advanced only.	
** To enable, see the <i>Viewing Equivalent RjDj Results</i> topic.	

Viewing Equivalent Rj/Dj Results (TDSJIT3 v2 Advanced Only)

Some standards require that timing jitter be separated into deterministic and random categories using a prescribed method called Equivalent Rj/Dj or Effective Rj/Dj. This method is described in Section 8 of the *Fibre Channel - Methodologies for Jitter and Signal Quality Analysis - MJSQ* document. This analysis makes some simplifying assumptions about the jitter characteristics, in an attempt to yield results that are consistent between different types of measurement instrumentation. It is known that the assumptions required for this analysis method generally result in conservative (overstated) Rj amounts.

By default, the Equivalent Rj/Dj tab is not enabled in the TDSJIT3 v2 user interface, although the measurement is always active and the results are always reported through GPIB. To enable the Equivalent Rj/Dj tab in the user interface, follow these steps:

1. Exit the TDSJIT3 v2 application if it is running.
2. Use a text editor (such as Notepad) to open the "jit3option.ini" file, which resides in the C:\Program Files\TekApplications\TDSJIT3v2 directory.

3. Locate the line that says "equivalentRjDj=false" and change it to "equivalentRjDj=true". If you cannot find the line, add it.
4. Save the file.
5. Restart the TDSJIT3 v2 application and take measurements. The application displays the Equivalent Rj/Dj tab in the Results menu for TIE measurements.

Results as Plots

The application can display the results as 2-dimensional plots for easier analysis. Before or after you take measurements, you can select and configure up to four plots. The last plot selected displays when the application completes sequencing.

If you set up plots after sequencing, the application displays the plot based on the current measurement and result.

Note: When taking measurements in the Free Run mode, you must stop the sequencing before you can use some plot features.

Table 29: Plot types

Plot type	Description
Histogram	Represents measurements sorted by value as a distribution of measurement values versus the number of times the value occurred
Time Trend	Represents the measurement values versus the time location
Cycle Trend	Represents the measurement values versus the index number of the measurement
Spectrum	Represents the frequency content computed using the FFT of the Time Trend plot
Bathtub*	Represents the Bit Error Rate versus the horizontal eye opening for TIE or PLL TIE measurements that include Rj/Dj analysis
Transfer Function*	Represents the magnitude ratio of two spectrums; the plot requires two measurements from the following set: Clock Period, Clock Frequency, Clock TIE, Clock PLL TIE, Data Period, Data Frequency, Data TIE, Data PLL TIE
Phase Noise*	For Clock TIE measurements only, represents the phase noise of a clock signal and is plotted in the frequency domain
* TDSJIT3 v2 Advanced only.	

Table 30: Measurements and available plots

Histogram	Time Trend	Cycle Trend	Spectrum	Bathtub*	Transfer Function***	Phase Noise***
All	All	All	All	TIE PLL TIE	Period, Frequency TIE PLL TIE	Clock TIE Clock PLL TIE
* TIE: RjDj analysis options are available in the Configure Meas General menu.						
** TDSJIT3 v2 Advanced only.						

Note: TIE and PLL TIE measurements refer to Clock TIE, Clock PLL TIE, Data TIE, and Data PLL TIE measurements unless specified.

Using a Separate Monitor to View Plots

If your oscilloscope setup includes a second monitor that extends the Windows desktop, you can select and drag the title bar of a plot window to position it in the second monitor. This allows you to simultaneously display a waveform on the oscilloscope, the TDSJIT3 v2 measurement results, and the plot for easy viewing.

Note: When setting your oscilloscope to include a second monitor, the Number of Colors setting for the second monitor must be the same number of colors as your oscilloscope.

Plot Usage

Histogram Plot Usage

Histogram plots display the results such that the horizontal axis represents the measurement value ranges and the vertical axis represents the number of times that the range of values occurred. Unlike most other plots, a histogram plot accumulates measurements over multiple acquisitions, up to a total population size of 2.0 billion.

Histograms are particularly useful in analyzing jitter. A histogram of the Time Interval Error (TIE) represents the basis of jitter analysis using a histogram approach. In a histogram, Deterministic Jitter (Dj) is bounded and shows up as a non-gaussian distribution. Random Jitter (Rj) is unbounded and the amplitude along the horizontal axis will continue to grow as more population is acquired. The TIE histogram is an excellent way to quickly assess jitter visually.

The vertical scaling (log versus linear) can be changed at any time without losing the accumulated statistics. The number of bins can also be changed at any time, since 2500 bins are always used for the actual computation. Autoset sets the Center and Span appropriately based on the currently accumulated results.

Note: Changing any of the horizontal scale controls (Center, Span, Refresh, Autoset) will cause the histogram plot to reset so that only the results from the most recent acquisition are displayed. This is because the bin size must be recalculated. If you change the Center or Span options, you can select the Refresh button, or the Run/Stop or Single buttons (to acquire data) to update the plot display.

Time Trend Plot Usage

A Time Trend plot is a waveform trace of a measurement versus time. This is useful, for example, in determining if the embedded clock in a serial bit stream is modulated outside the capabilities of your receiver to recover the clock. If the TIE time trend plot starts to take an unexpected periodic shape, then this could indicate that you have uncorrelated periodic jitter from crosstalk or from power supply coupling.

Cycle Trend Plot Usage

A Cycle Trend plot shows measurement values versus measurement index, where the indexes are always equally spaced along the horizontal axis. In contrast, the measurement values on a Time Trend plot are not equally spaced along the horizontal time axis.

Spectrum Plot Usage

A Spectrum plot is obtained from the Fast Fourier Transform of a Time Trend plot. This plot is useful in identifying frequency components that contribute to timing errors, such as modulation of the measurements.

When the signal has a repetitive data pattern, an analysis on the TIE Spectrum of the signal can be used to separate Random Jitter (R_j) from Deterministic Jitter (D_j) as well as separate D_j components of Periodic Jitter (PJ) and other D_j components such as ISI and DCD. The frequency of periodic jitter spikes that do not correlate to frequencies contained in the data pattern can be a clue that you should look at frequencies of different components in your design as possible sources of jitter.

Bathtub Plot Usage (TDSJIT3 v2 Advanced Only)

The Bathtub curve plot is a convenient way to visualize how the jitter eye opening varies for different bit error rate assumptions. Many communications standards call for Total Jitter to be measured at 10-12 BER. The eye opening represented by the Bathtub Curve is what is left of the unit interval after the total jitter measurement is subtracted.

Transfer Function Plot Usage (TDSJIT3 v2_Advanced Only)

A Transfer Function plot shows the magnitude ratio of the spectrums of two measurements. In the next equation, X(t) is a jitter measurement at the input of a device, and Y(t) is a jitter time trend at the output of the device. The Transfer Function plot can be used to show the following function, where X(f) is the Fourier Transform of X(t):

$$H(f) = \frac{|Y(f)|}{|X(f)|}$$

The horizontal axis of the Transfer Function plot goes up to the nyquist frequency of X or Y, whichever is lower. These plots work best if averaged across multiple acquisitions to reduce the effects of measurement noise.

Phase Noise Plot Usage (TDSJIT3 v2_Advanced Only)

The Phase Noise plot shows a frequency domain view of the jitter noise on a waveform normalized in an industry-standard way. The vertical axis is logarithmic and uses the units of dBc/Hz, which means "decibels (relative to the carrier) per Hertz." The horizontal axis is logarithmic. In addition to showing the phase noise curve, this plot allows the integrated noise between two user-selectable frequencies to be displayed.

Creating Plots

Before or after you take measurements, you can set up plots in the Plots Create menu. To create a plot, follow these steps:

1. Select Plots> Create. View the Plots Create menu.
2. Select a measurement from the list of available measurements and sources shown on the left side.
3. Select a plot format from the Add Plot buttons. The selected measurement and plot type appears in the list of Plots shown on the right side. If results are available, the application displays the plot; otherwise the plot will appear after a measurement sequence is complete.
4. Add another plot format for the current measurement, or select a different measurement and add plots.

Note: The Phase Noise plot and Bathtub plot (both in TDSJIT3 v2 Advanced only) are only enabled when a TIE-type measurement is chosen. The Bathtub plot also requires that the RjDj analysis be enabled in the Configure Meas TIE: RjDj menu.

Table 31: Plots Create menu options

Option	Description
List of active measurements	Selects the measurement to plot
Add Plot buttons	Selects the type of plot
Plots	Lists up to four selected plots; use this list to clear plots
Clear button	Clears the selected plot
Clear All button	Clears all plots

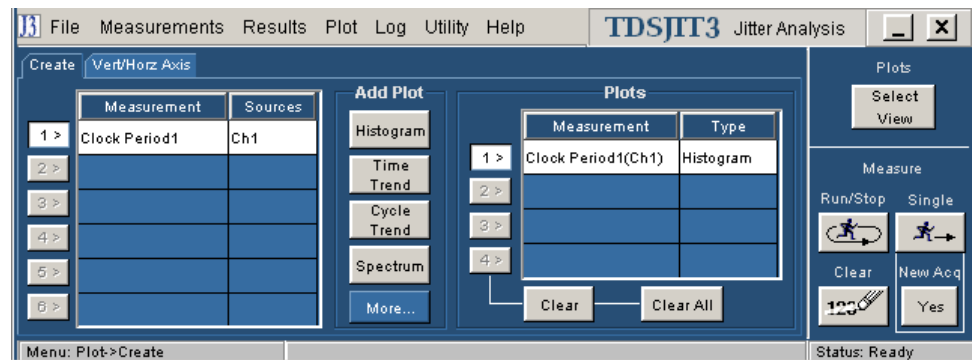

Figure 44: Plots Create menu

Configuring Plots

After you create the plots, you can further configure the axes for each measurement and plot combination (except for a Cycle Trend plot). To configure a plot, follow these steps:

1. Select Plot> Vert/Horiz Axis or the Vert/Horiz Axis tab.
2. Select a measurement in the Plots list of measurements and plot types on the left side. This causes the area to the right of the table to display options relevant to the selected measurement and plot type.
3. Configure the plot. The application displays the reconfigured plot.

Table 32: Vert/Horiz axis options for a Histogram plot

Area/option	Description
Vertical Scale	
Log	Depicts the vertical axis in a logarithmic scale
Linear	Depicts the vertical axis in a linear scale (default)
No of Bins	Defines resolution by the number of bins into which Span is divided: 25, 50, 100, 250 (default), or 500
Horizontal Scale	
Center	Numerical value for the horizontal center position of the Histogram after Refresh
Span	Numerical value for the total horizontal range of the Histogram after Refresh
Autoset*	Uses the latest results to determine the logical values for the Center and Span options if the population of the measurement is three or more, and then redraws the plot
Refresh*	Updates the plot with the latest Center and Span values entered
* Changing the Horizontal Scale causes any accumulated results across multiple acquisitions to be lost, and only the results of the most recent acquisition will be displayed.	

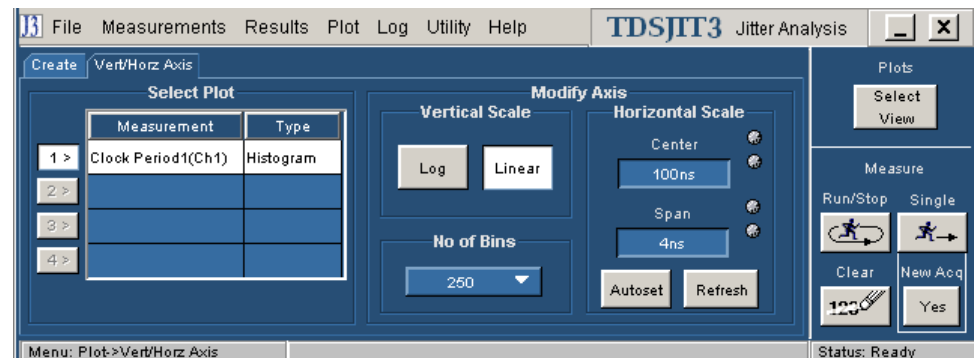

Figure 45: Vert/Horiz menu for a Histogram plot

Table 33: Vert/Horiz axis options for a Time Trend plot

Option	Description
Vector	Measurement points connect with straight lines (default)
Bar	Places a vertical bar at the horizontal position of each measurement with a height (positive or negative) that represents the value of that measurement; a horizontal baseline represents the mean value of the Time Trend

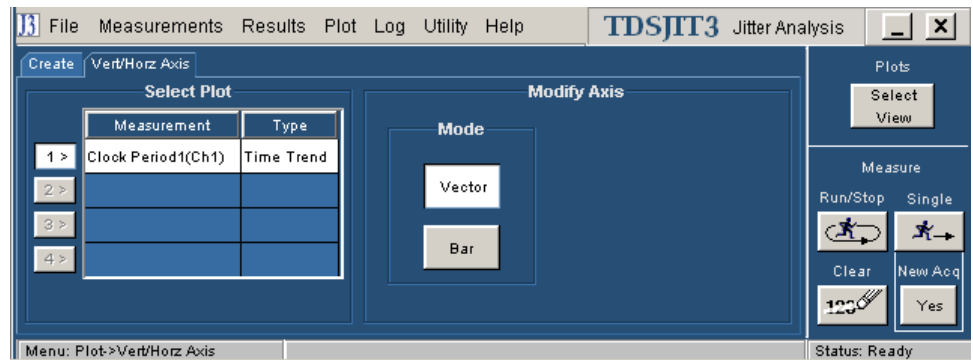

Figure 46: Vert/Horiz menu for a Time Trend plot

Table 34: Vert/Horiz axis options for a Spectrum plot

Area/option	Description
Vertical Scale	
Log	Depicts the vertical axis in a logarithmic scale
Linear	Depicts the vertical axis in a linear scale (default)
Baseline	Numeric value (expressed as a base-10 exponent) at the bottom of a logarithmic vertical scale
Horizontal Scale	
Log	Depicts the horizontal axis in a logarithmic scale
Linear	Depicts the horizontal axis in a linear scale (default)
Mode	<p>Selects whether the plot shows only the most recent spectrum, the uniform average of all spectrums since the last time the results were cleared, or the peak of the envelope of all spectrums since the last time the results were cleared</p> <p>Normal updates the plot with current values (default)</p> <p>Average averages the magnitude values at each frequency</p> <p>Peak Hold keeps the maximum value at each frequency</p>

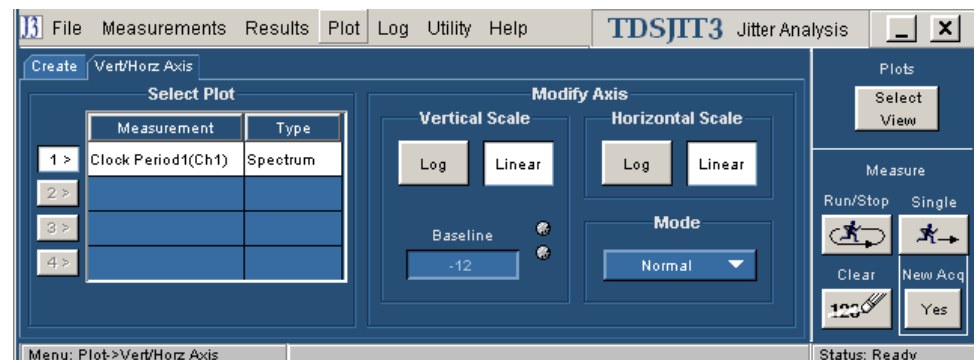

Figure 47: Vert/Horiz menu for a Spectrum plot

Table 35: Vert/Horiz axis options for a Bathtub plot

Option	Description
Linear	Depicts the vertical axis in a linear scale
Log	Depicts the vertical axis in a logarithmic scale (default)
Minimum Displayed BER=1E-?	Numeric value (expressed as the negative of a base-10 exponent) at the bottom of the logarithmic vertical scale; default = 12, representing 10^{-12}

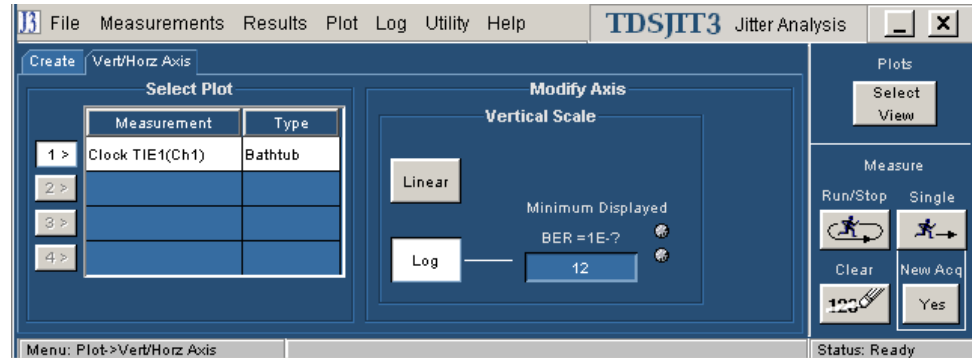

Figure 48: Vert/Horiz menu for a Bathtub plot

Transfer Function Definition Options

The Transfer Function plot requires two measurements from the following set: Clock Period, Clock Frequency, Clock TIE, Clock PLL TIE, Data Period, Data Frequency, Data TIE, and Data PLL TIE.

Table 36: Transfer Function Definition configuration

Option	Description
Numerator	Measurement for which the magnitude spectrum is used as a reference
Denominator	Measurement for which the magnitude spectrum is used to normalize the numerator
Invert	Swaps the measurements used as the Numerator and as the Denominator
OK	Accepts changes and closes
Cancel	Discards changes and closes

Transfer Function Definition Menu

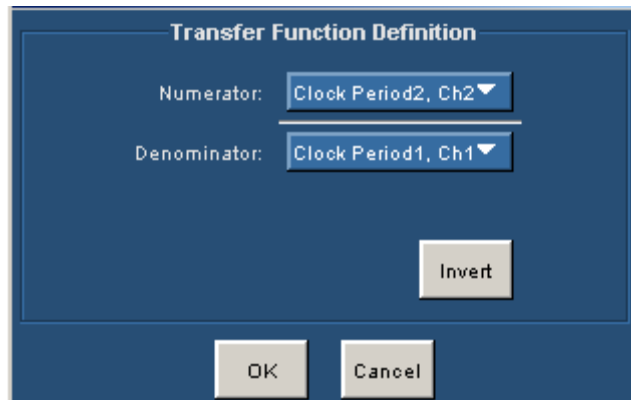

Figure 49: Transfer Function Definition options

Table 37: Vert/Horiz axis options for a Transfer Function plot

Area/option	Description
Vertical Scale	
Log	Depicts the vertical axis in a logarithmic scale (default)
Linear	Depicts the vertical axis in a linear scale
Horizontal Scale	
Log	Depicts the horizontal axis in a logarithmic scale (default)
Linear	Depicts the horizontal axis in a linear scale
Mode	Selects whether the plot shows only the most recent spectrum, or the uniform average of all spectrums since the last time the results were cleared (default) Normal updates the plot with current values Average averages the magnitude values at each frequency
Function Def Invert	Swaps the measurements used as the Numerator and as the Denominator; resets any averaging to include only the most recent acquisition

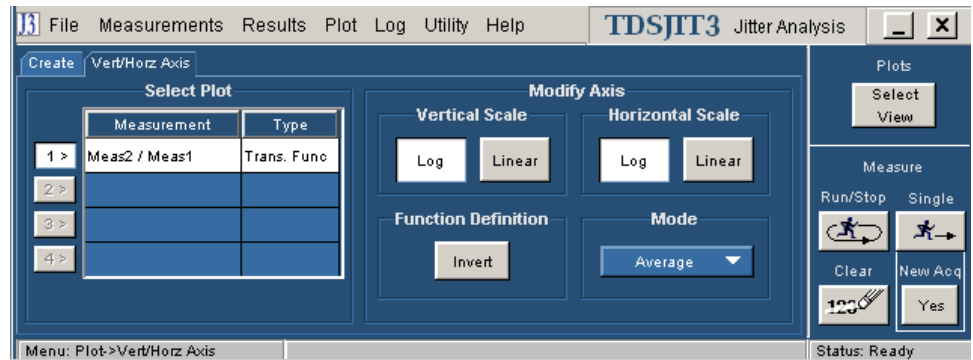

Figure 50: Vert/Horiz menu for a Transfer Function plot

Table 38: Vert/Horiz axis options for a Phase Noise plot

Area/option	Description
Vertical Position	
Baseline	Numeric value at the bottom of a logarithmic vertical scale
Integrated Noise	
Lower Limit	Sets the lower frequency limit over which noise will be integrated
Upper Limit	Sets the upper frequency limit over which noise will be integrated
RMS	Displays the RMS value of integrated noise between the lower and upper limits.

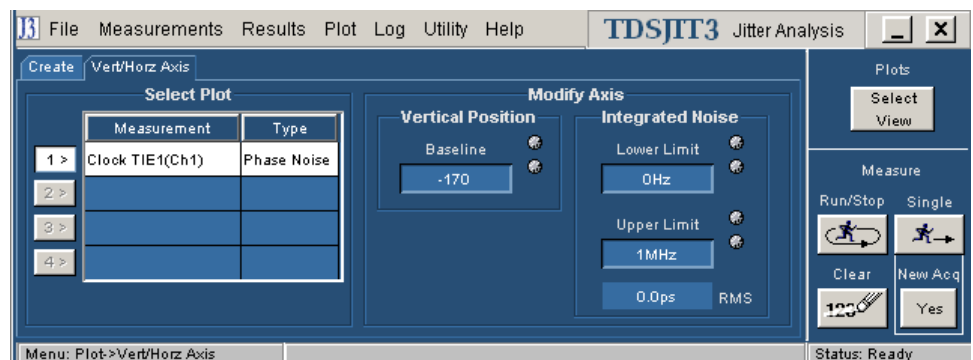

Figure 51: Vert/Horiz menu for a Phase Noise plot

Working with Plots





You can create and configure up to four plots. By default, all four plot windows are overlaid on the upper half of the display, but each window can be moved, resized, or dragged to a second monitor. The application includes tools to help you select which plots to view, to size and position the plot windows, to save plot information, to use the zoom function, and to use the cursors functions.

If your Windows desktop is extended to a second monitor, you can drag the plots window to the second monitor.

Note: When sequencing is complete, the plot window displays with the last plot selected. The plot window also updates whenever you reconfigure a plot.

Toolbar Functions in Plot Windows

Each plot window includes the following tool groups:

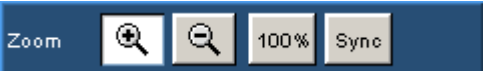
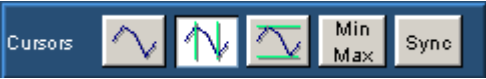
-  to save the plot contents to a file (data or image) or to export to a reference memory location on the oscilloscope
-  to position the plot window in default positions and sizes when the window is displayed on the oscilloscope
-  to place a selected plot in the foreground in one of the two default positions
-  to select between the Zoom tools or the Cursors tools
-  to use the Zoom tools
-  to use the Cursor tools

Selecting and Viewing a Plot

To select and view an existing plot, follow these steps:

1. Select the  button. The Locate Window At dialog box appears.

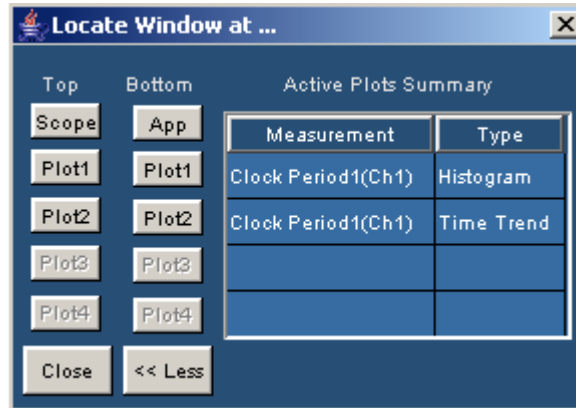



Figure 52: Locate Window At options

The Select View button appears on the Control Panel and in the toolbar of every plot window.

2. To view the first plot in the Active Plots Summary table on the top half of the display, select the Plot1 button from the Top column. To view this plot on the bottom half of the display, select Plot1 from the Bottom column.

You can place the other defined plots on the top or bottom of the display by similar steps. Select the Scope button to bring the oscilloscope interface to the top of the display. Select the App button to bring the TDSJIT3 v2 main window to the bottom.

3. Select Close or  to dismiss the Locate Window At dialog. This dialog must be dismissed before the TDSJIT3 v2 windows will respond to any other commands.



Tip If you have a keyboard, you can use the Alt-Tab Window shortcut to quickly select a window for viewing.





Tip If you have a second monitor, you can select and drag the title bar of a plot window to position it in the other monitor.

Moving and Resizing a Plot

You can move and resize plot windows the same way you would move and resize any window.

The plot position tools can move a plot to the upper or lower half of the oscilloscope display. The tools also return the plot to the original size. To position a plot quickly on the oscilloscope, select one of the following tools in the plot window:

-  positions the plot in the upper half

-  positions the plot in the lower half

Deleting Plots

You can remove individual or all selected plots. To remove an individual plot, follow these steps:

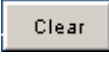

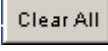

1. Select Plots> Create or the Create tab.
2. Select the plot to be removed in the list of Plots on the right side.
3. Select the  button.

To remove all selected plots, select the  button.

The plot window updates and removes the deselected plot from the display.

Using Zoom in a Plot



Once you have created a plot, you can use the Zoom tools to examine the data at various scales. You can use the buttons in the Zoom toolbar to do the following tasks:

-  to examine a small portion of a waveform in greater detail
-  see the a larger portion of the waveform
-  to see the entire available waveform
-  for Time Trend plots, to synchronize the zoom window of the oscilloscope with the zoom window of the TDSJIT3 v2 application

 **Tip** If you prefer to use the zoom functions in a plot window with your finger, you can activate the Touch Screen on the oscilloscope provided the model you are using has this feature.

Zooming In





To examine a portion of the waveform in greater detail, follow these steps:

1. In the  Control tools, select the  button. This step is not necessary if the Zoom toolbar is already visible.
2. In the Zoom toolbar, select the  button.
3. To zoom the horizontal scale by a factor of two without affecting the vertical scale, click-and-release on a point of interest in the waveform.
4. To zoom in by an arbitrary amount both horizontally and vertically, use a click-drag-release action with the mouse. After you click and begin dragging, a bounding box will appear to show what part of the waveform will be expanded upon release.

The two zoom methods may be repeated in any order until the maximum zoom is reached.



Zooming Out

To reduce the scale of a plotted waveform so that more of the waveform can be seen, follow these steps:

1. In the  Control tools, select the  button. This step is not necessary if the Zoom toolbar is already visible.
2. To zoom out partially, select the  button in the Zoom toolbar and then click anywhere on the waveform. The view is restored to the zoom values that existed before the most recent zoom-in. Clicking multiple times will restore successively earlier views.
3. To zoom out completely, select the  button. The view will be restored to its initial zoom settings, in which the entire waveform can be seen.

Using Zoom Sync (Time Trend Only)

By using the Zoom Sync function, you can synchronize the zoom window of the oscilloscope with the current horizontal axis limits of a Time Trend plot. To do so, follow these steps:

1. Create, configure, and display a Time Trend plot.
2. In the  Control tools, select the  button. This step is not necessary if the Zoom toolbar is already visible.
3. Use the zoom tools until the desired portion of the Time Trend waveform is visible.
4. Select the  button. This turns on the zoom mode on the oscilloscope, and adjusts the horizontal zoom scale and position to correspond closely with those of the Time Trend plot.

Note: Selecting the Sync button will not bring the oscilloscope user interface to the foreground if it is obscured by a plot window. To make the oscilloscope visible, use the Select View button or the Windows Alt-Tab shortcut.

Since the zoom window of the oscilloscope has a limited number of valid scale factors, the time scale synchronization is not necessarily an exact match.





Using Cursors in a Plot

Cursors allow you to view numerical values associated with a plot based on cursor locations. There are two cursor modes: Vertical-paired and Horizontal-paired. Each mode displays two cursors in a plot.

Note: You can only use one mode at a time; vertical or horizontal-paired but not both.

You can use the buttons in the Cursor toolbar to do the following tasks:

-  to display the horizontal coordinate where each cursor touches the plot and the difference (delta) between the cursors

-  to display the vertical coordinate where each cursor touches the plot and the difference (delta) between the cursors
-  to position cursors on minimum and maximum values
-  for Time Trend plots, to synchronize the oscilloscope cursors with the position of the plot cursors
-  to remove cursors from the display

 **Tip** The most precise way to move the cursors in a plot window is with the Multipurpose knobs of the oscilloscope provided the cursors are associated with the Multipurpose knobs (focused).

Focusing Cursors

The cursors do not always become focused (associated with the Multipurpose knob) when you select a plot window. Sometimes the application can lose focus of the cursors if you switch windows, switch cursors when using both, use the Min/Max button, or use the Sync cursors between a Time Trend plot and the oscilloscope and then move the oscilloscope cursors.



To focus the cursors, select the cursor in the plot window.

Using Vertical Cursors in a Plot

Vertical cursors appear as two vertical lines in a plot window. They enable you to read the horizontal coordinates where each line touches the plot and also view the horizontal difference (delta) between the two cursors.

In addition, a red cross appears where each cursor intersects the plotted waveform. The vertical value at each of these crosses (as well as the vertical delta) is shown in the plot window.

To use Vertical cursors while viewing a plot, follow these steps:



1. In the Control tools, select the  button.
2. In the Cursor tools, select the  button.
3. Select and drag either cursor line, or use the Multipurpose knobs on the oscilloscope to move the cursor to the part of the plot desired.

The cursor readout changes value to reflect the cursor position.

 **Tip** If you prefer to move the cursors in the plot window with your finger, you can activate the Touch Screen on the oscilloscope provided the model you are using has this feature.



Note: You can drag cursors only when the Zoom functions are disabled.

 **Tip** The most precise way to move the cursors in the plot window is with the Multipurpose knobs of the oscilloscope provided the cursors are associated with the Multipurpose knobs (focused).

 **Tip** Use the  button to place the Vertical cursors at the levels corresponding to the minimum and maximum values within the currently displayed horizontal extent of the plot.

Additional Ways to Use Vertical Cursors



You can also use the Vertical Cursors in the following ways:

- Use the  button to place the two cursors at the positions corresponding to the minimum and maximum vertical values within the plot. If the plot display has been zoomed, the minimum and maximum values within the current horizontal limits of the zoom are used.
- For Time Trend only, you can use the  button to synchronize the oscilloscope cursors with the plot cursors' positions.
- Min/Max is most useful for Trend Plots. The Max (half of the feature) is useful for Spectrum plots.

Using Horizontal Cursors in a Plot

Horizontal cursors appear as two horizontal lines in a plot window. They enable you to read the vertical coordinates where each line touches the plot and also view the horizontal difference (delta) between the two cursors.

To use Horizontal cursors while viewing a plot, follow these steps:



1. In the Control tools, select the  button.
2. In the Cursor tools, select the  button.
3. Select and drag either cursor line, or use the Multipurpose knobs on the oscilloscope to move the cursor to the part of the plot desired.

The cursor readout changes value to reflect the cursor position.

 **Tip** If you prefer to move the cursors in the plot window with your finger, you can activate the Touch Screen on the oscilloscope provided the model you are using has this feature.

Note: You can drag cursors only when the Zoom functions are disabled.

 **Tip** The most precise way to move the cursors in the plot window is with the Multipurpose knobs of the oscilloscope provided the cursors are associated with the Multipurpose knobs (focused).

 **Tip** Use the  button to place the Horizontal cursors at the levels corresponding to the minimum and maximum values of the visible portion of the plot.

Using Cursors Sync (Time Trend Only)

You can select the Sync button to synchronize the oscilloscope cursors with those in a Time Trend plot.

Using Min/Max Cursors

You can select the Min/Max button to position cursors to the maximum and minimum values as appropriate horizontally or vertically.

Min/Max cursors are most useful for Time Trend plots. The Max (half of the feature) is useful for Spectrum plots.

Exporting Plot Files

There are several ways you can export plot information from the TDSJIT3 v2 application for use in other applications:

- You can export the mathematical data that is represented in the plot figure. This may be useful if you wish to perform additional processing on the data.
- You can create an image file that captures the current plot view. This may be a useful way to document your results.
- You can export a plot to a reference memory location in the oscilloscope. This may be useful if you want to use math expressions in the oscilloscope to further process the measured data.



The  tool offers the following choices from the Save drop-down list:

- Data saves the numerical values from the plot window in text or MATLAB format
- Fig saves the contents of the plot window as an image file
- Ref saves the plot in an oscilloscope reference memory location (Ref1, Ref2, Ref3, or Ref4)

Note: Export plot functions are disabled whenever the application is actively sequencing.

Exporting Raw Plot Data

The waveform image in each plot is typically only 500 by 160 pixels, but the data that it represents may be several million samples of double-precision floating-point information. Exporting this data allows you to perform additional processing or derive custom measurements.

Note: The TDSJIT3 v2 application can produce files that are too large for most spreadsheet programs to load completely. However, you can still use a text editor to view the entire file.

To export the mathematical data that was used to create a plot, follow these steps:

1. Select Data as the Export tool in the upper left corner of the plot window. A file chooser window appears.
By default, the chooser provides a filename derived from the current date and time, and offers to place the data in a folder called "plotData" in the TDSJIT3 v2 file area. The default data type is ASCII text.
2. Use the controls at the top of the file chooser to select the directory where you would like to save the data.
3. If ASCII text is not the desired data format, use the drop-down list labeled "Files of type:" to select another file type. The choices are:
 - ASCII Text (.txt) – ASCII text that is readable by an editor such as Wordpad

- Comma Separated Values (.csv) – ASCII text that can be loaded into a spreadsheet
- MATLAB (.mat) – Binary data in the native MATLAB 5.0 format

 **Tip** Binary files typically use about 40% as much disk space as text files.

4. If you have a keyboard, you can change the filename.
5. Select Save to save the data.

Note: Files with .txt and .csv extensions are identical except for the extension.

Exporting Plot Images

You can save the exact waveform that you see in the plot window, including any cursors. This may be convenient for reports, engineering records, or sharing interesting results with your peers.

To create an image file from your plot, follow these steps:

1. Adjust the zoom and/or cursors to get the view you wish to save.
2. Select Fig as the Export tool in the upper left corner of the plot window. A file chooser window appears.

By default, the chooser provides a filename derived from the current date and time, and offers to place the image file in a folder called "plotFigure" in the TDSJIT3 v2 file area. The default image format is Portable Network Graphics (.png).

3. Use the controls at the top of the file chooser to select the directory where you would like to save the image.
4. If PNG is not the desired image format, use the drop-down list labeled "Files of type:" to select another format. The choices are:
 - Windows Bitmap (.bmp) – Uncompressed pixel map in the standard Windows format
 - JPEG File Interchange Format (.jpg) – A lossy, compressed format
 - Portable Network Graphics (.png) – A lossless, compressed format that offers good portability
5. If you have a keyboard, you can change the filename.
6. Select Save to save the data.

Exporting a Plot to a Reference Memory Location

You can transfer the plot to a reference memory location on the oscilloscope, and then save it as a .wfm file. To do so, follow these steps:

1. Select Ref as the Export tool in the upper left corner of the plot window.
2. Select the desired Ref and then OK.
3. Use the export function of the oscilloscope to save the plot in the reference memory location to the hard disk as a .wfm file.

Saving Information to Log Files

The application includes the following Log menus:

- Statistics
- Measurements
- Worst Case Waveforms

Logging Statistics

The application can continuously log (save to file) the calculated statistics, or save a snapshot of the current statistics. You can save the statistics to a "comma separated value" (.csv) file to import into a text editor, a spreadsheet, or an analysis tool.

Note: The TDSJIT3 v2 application can produce .csv files that are too large for most spreadsheet programs to load completely. However, you can still use a text editor to view the entire file.

By default, all actual measurements are selected. You can select individual measurements by selecting the measurement number or row in the table on the left side of the menu.

To log statistics to a file, follow these steps:

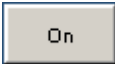
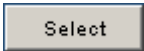
1. Select Log> Statistics. The Log Statistics menu appears.
2. Select measurements that you want to log in the table on the left of the menu or choose the "Yes to All" button. You can also choose "No to All" to clear the current selection list.
3. To log statistics continuously, select the  button. The Log File Name menu appears. The default directory is C:\TekApplications\TDSJIT3v2\log.
4. Select an existing file or a new file to contain the saved statistics for all selected measurements.
5. Select the  button. The file name menu closes.
6. To stop logging, select the Off button or the Delete button to delete the current statistics file.

To save a snapshot of current statistics (as shown in the Results menu), under Save Current Statistics, select the Save button to save the current statistics to a statsSnapshot.csv file. The default directory is C:\TekApplications\TDSJIT3v2\log.

Note: For either type of logging, you can use the Delete button to browse and delete files.

Table 39: Log Statistics configuration

Option/button	Description
Log Statistics	Enables the application to continuously save the statistical results for all selected measurements
On button	Browse to select or enter a file name and enable logging
Off button	Disable continuous logging
Delete button	Browse to select and delete .csv files
Save Current Statistics	Saves a snapshot of the current statistics for the current acquisition and accumulated acquisitions for selected measurements
Save button	Browse to select a file name and save a Snapshot of statistics
Delete button	Browse to select and delete .csv files

Logging Measurements

You can log the actual data points as measurement files. You can log data points continuously or save the data points for the current acquisition. You can save the data points to a "comma separated value" (.csv) file to import into a text editor, a spreadsheet, or an analysis tool.

Note: The TDSJIT3 v2 application can produce .csv files that are too large for most spreadsheet programs to load completely. However, you can still use a text editor to view the entire file.

To log measurements, follow these steps:

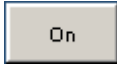
1. Select Log> Measurements> Configure. The Log Measurements menu appears.
2. Select measurements that you want to log or choose the "Yes to All" button. (You can also choose "No to All" to clear the current selection list.)
3. To log measurements continuously, select the  button. The Choose Log Measurement Directory menu appears.
4. Select a directory to contain the saved measurement files (one file for each measurement).
5. Select the OK button. The Choose Log Measurement Directory menu closes.
6. To stop logging, select the Off button.

To save current data points in measurement log files, under Save Current Measurements, select the Save button to browse for a directory and to save a snapshot of the data points to a file for each selected measurement.

Note: For either type of logging, you can use the Delete button to browse and delete individual measurement files. Using either log measurement feature provides a directory browser to navigate or create new folders.

Table 40: Log Measurements configuration

Option/button	Description
Log Measurements	Enables the application to save all selected measurements
On button	Browse to select or enter a directory name and turn on logging
Off button	Turn off continuous logging
Delete button	Browse to select and delete .csv files
Save Current Measurements	Saves a snapshot of the current measurements for the current acquisition and accumulated acquisitions for selected measurements
Save button	Save current and accumulated measurements
Delete button	Browse to select and delete .csv files

File Names for Logging Measurement Files

The application automatically names the files for you based on a combination of the measurement name and source used. You can select the File Names tab to see the file names created by the application.

You can also choose a directory for measurement log files.

Logging Worst Case Waveforms

You can use the Log Worst Case menus to save the acquired waveforms whenever a selected measurement exceeds the highest or lowest prior value. When enabled, the waveforms are saved to a set of .wfm files including the qualify waveform if active.

To log worst case waveforms, follow these steps:

1. Select Log> Worst Case> Configure.
2. Select measurements for which you want to log the worst case waveforms, or choose the "Yes to All" button. (You can also choose "No to All" to clear the current selection list.)
3. To log worse case waveforms continuously, select the  button. The Log Worst Case Waveforms menu appears.
4. Select a directory to contain the saved waveforms.
5. Select the OK button. The Log Worst Case Waveforms menu closes.
6. To stop logging, select the Off button.

Note: Use the Delete button to delete all the .wfm files in the selected directory.

Table 41: Log Worst Case Waveforms configuration

Option/button	Description
Log Worst Case Waveforms	Enables the application to save worst case waveforms for all selected measurements
On button	Browse to select or enter a directory name and turn on logging
Off button	Turn off continuous logging
Delete button	Browse to select and delete .wfm files

File Names for Logging Worst Case Waveforms

The application automatically names the files for you based on a combination of the following information:

- Measurement name
- Source of the waveform, such as Ch1
- Whether the file is a maximum or minimum value waveform

You can select the File Names tab to see the file names created by the application.

If a qualify waveform is saved, the file name will include the following information:

- QUAL to identify it as a qualify waveform if active
- Source of the waveform, such as Ch2

Saving and Recalling Setup Files

You can use the File menus to save and recall different application setups and recently accessed files.



Do not edit a setup file or recall a file not generated by the application.

Saving a Setup File

To save the application and oscilloscope settings to a setup file, follow these steps:

1. Select File> Save. The Save dialog box appears. View the Save browser.
2. In the file browser, select the directory in which to save the setup file or use the current directory.
3. To view details about existing files, such as size, type, and date modified, select the Details tool.
4. Use the keyboard to enter a new file name.

The application appends an ".ini" extension to the name of the application setup file.

5. Select the  command button. If the selected filename already exists, a confirmation dialog appears that allows you to cancel the operation.

Note: The application also saves the oscilloscope setup to a ".set" file when you save an application setup. Both the application .ini file and oscilloscope .set file have the same file name.

To view details, such as file size, type, and date modified, select the  Details tool.

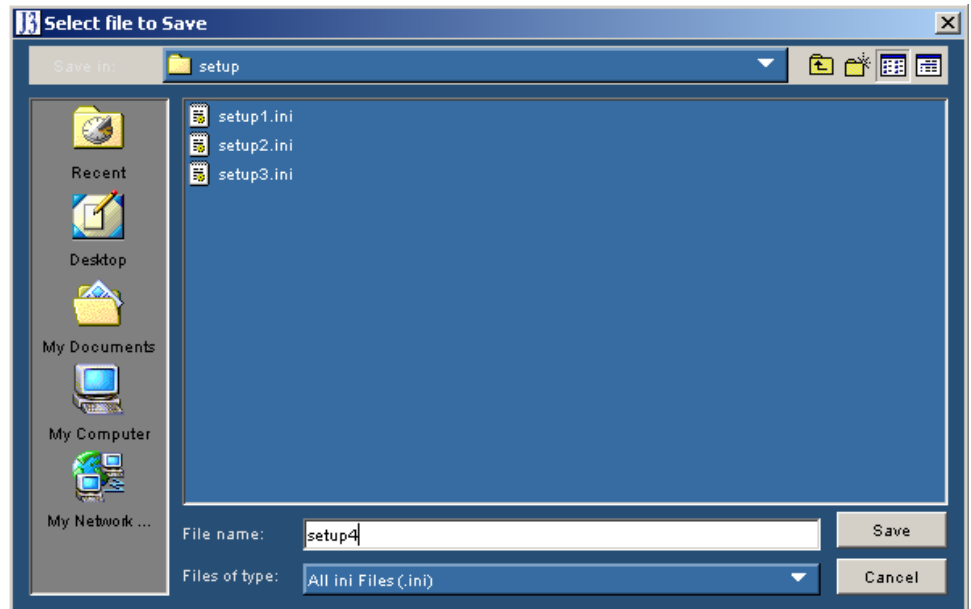

Figure 53: File Save browser

Recalling a Saved Setup File

To recall the application and oscilloscope settings from saved setup files, follow these steps:

1. Select File> Recall. The Recall dialog box appears. View the Recall browser.
2. In the Recall dialog box, select the directory from which to recall the setup file.

To view details about the files in the directory, such as size, type, and date modified, select the Details tool.

3. Select a setup file name, and then select Open.

Note: The application recalls the .ini setup file and the associated oscilloscope setup if the application can find a .set file with a matching name.

 Do not edit setup files. If you try to recall a setup file that has been edited, the recall operation fails.

 If a matching .set file is not found or if the .set file does not recall correctly to the oscilloscope, then a warning appears that says that the oscilloscope recall failed while the TDSJIT3 v2 application recall succeeded.

To view details, such as file size, type, and date modified, select the  Details tool.

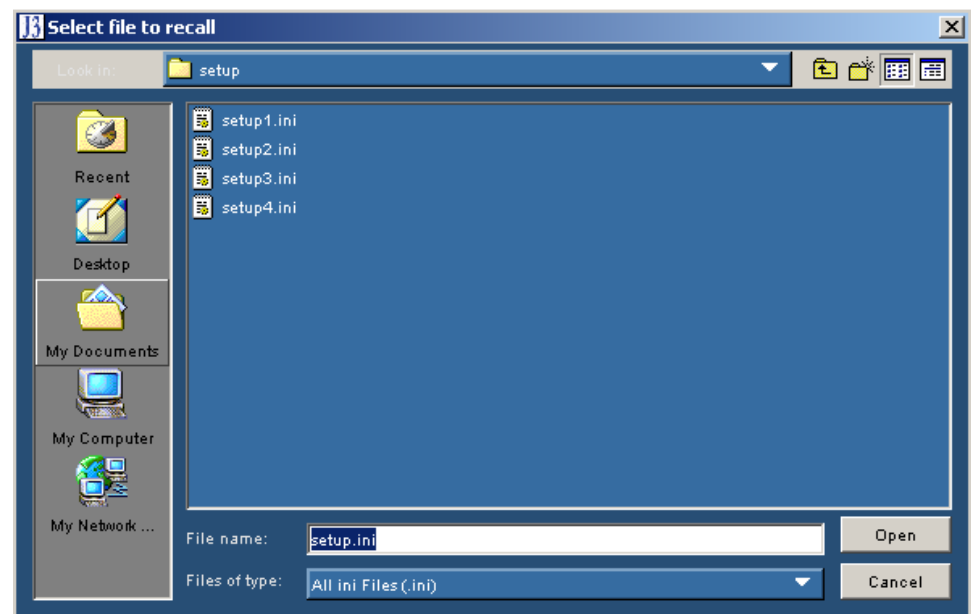

Figure 54: File Recall browser

Recalling the Default Setup

To recall the default application settings, select File> Default Setup. Most of the menu options are set to the same values or selections as when you launch the application.

Recalling a Recently Saved or Accessed Setup File

To recall a recently saved or accessed setup file, select File> Recent Files and then the file from the drop down list of setup file names.

Note: The application also recalls the associated oscilloscope setup if the application can find a .set file with a matching name.

 Do not edit setup files. If you try to recall a setup file that has been edited, the recall operation fails.

 If a matching .set file is not found or if the .set file does not recall correctly to the oscilloscope, then a warning appears that says that the oscilloscope recall failed while the TDSJIT3 v2 application recall succeeded.

Recall Recent Files Example

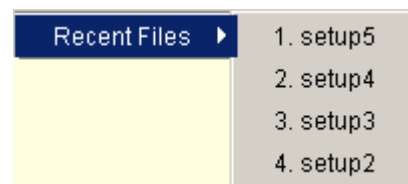

Figure 55: Recall Recent files example

Recalling a Setup File from a Earlier Version of Software

Setup files that were saved using a prior version of the TDSJIT3 application may be recalled. For those features that were not present in the prior version, reasonable default settings are used. You may wish to verify that settings not specified by the old file are acceptable.

Note: Setup files from previous versions may include directory paths such as "C:\TekApplications\TDSJIT3\...", whereas the v2 application defaults to "C:\TekApplications\TDSJIT3v2\...". If you would like your converted setup files to use the TDSJITv2 directory, recall the existing setup file, use the Graphical User Interface to change any file paths to use the new directory structure, and then save the setup.

After you recall the setup file, you may save the setup again to create a setup file with the latest format. Use a different filename if you wish to retain the old setup file.

Vertical reference levels receive special attention during setup file conversion. If all of the reference levels for an active source are the default values (where High is set to 1.0 V, Mid is set to 0.0 V, Low is set to -1.0 V, and the Hysteresis is set to 0.03 V), then that source shall be configured for Automatic reference levels.

Otherwise, the source shall be configured for Manual reference level and the reference levels in the setup shall be used exactly as they are. For more information, see the Automatic Versus Manual Reference Voltage Levels topic.

Some prior versions of the TDSJIT3 application used a configuration file ("jit3option.ini") to establish the order of the phase-locked loop used for clock recovery in PLL TIE measurements. The current TDSJIT3 application includes these controls and ignores the loop-order settings in the older configuration file. You can set these values manually, if necessary, and save a new setup file. After this, you can use the new setup file to ensure that the PLL settings are properly set.

Note: Setup files from the TDSJIT2 application are not supported.

Docking and Undocking the Jitter Analysis Window

The Dock function positions and locks the TDSJIT3 v2 application in the lower half of the oscilloscope display and the oscilloscope application in the upper half of the display.

The Undock function unlocks the window and allows you to move the application to another position in the oscilloscope display or drag it to a second monitor; the oscilloscope display returns to full size.

The Dock and Undock functions are available under the File menus in the menu bar.

Acquisition Timeout Utility

The Acq Timeout utility sets the delay (in seconds) that the application allows between an acquisition start and when a waveform is expected.

- Auto allows the application to adjust the delay according to the record length and measurement complexity
- User allows you to set the appropriate delay value from 30 seconds to 24 hours (86400 seconds) in 30 second increments

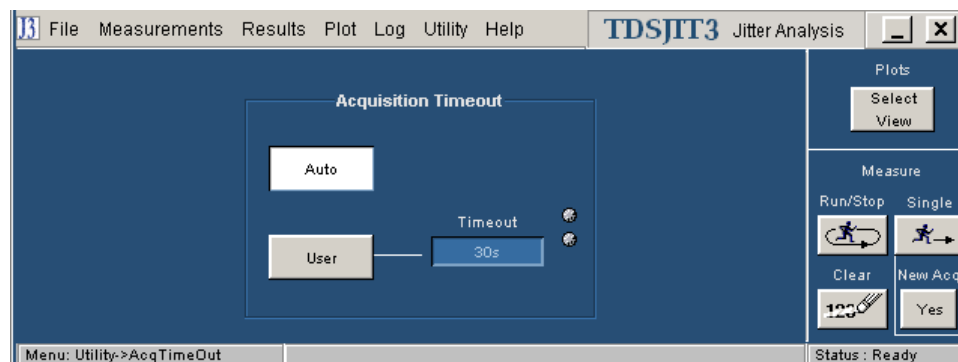



Figure 56: Acquisition Timeout options

Warnings Utility

The Warnings utility lists errors that have occurred and a brief description of each. To clear the contents from the file, select the Clear button.

Warnings are also designated with a yellow  icon and errors with a red  icon in the status bar along the bottom of the TDSJIT3 v2 application window. Once a message appears in the status bar, you can dismiss it by selecting the View Log button in the status bar, or by selecting the Clear results button. Neither action removes the message from the warnings log file.

Tutorial

The purpose of this tutorial is to familiarize you with the basic functions of the TDSJIT3 v2 application and menus. This tutorial teaches you how to do the following basic tasks:

- Set up the application
- Take two types of measurements
- View the results as statistics and as plots

Before you begin the tutorial, you must do the following tasks:

- Set up the oscilloscope
- Start the application
- Recall the tutorial waveform

Note: The screen captures shown are from a TDS7000 oscilloscope; there may be minor differences in the screens from other oscilloscope models.

Setting Up the Oscilloscope

To set up the oscilloscope, follow these steps:

1. In the oscilloscope menu bar, select File> Recall Default Setup to set the oscilloscope to the default factory settings.
2. Press the individual CH1, CH2, CH3, and CH4 buttons as needed to remove active waveforms from the display.

Starting the Application

The way you start the application depends on the oscilloscope model. To start the application, do one of the following:

- Select App > Jitter Analysis – Advanced
- Select File > Run Application > Jitter Analysis – Advanced in the oscilloscope menu bar
- Select Analyze > Jitter Analysis – Advanced

If you are using the TDSJIT3 v2 Essentials application, select Jitter Analysis - Essentials.

If the Jitter Wizard displays, select the Cancel button.

Waveform Files

The application includes two waveform files to use with this tutorial:

- j3clk1.wfm (clock signal)
- j3dat1.wfm (data signal)

Recalling a Waveform File

The way you recall a waveform to reference memory depends on the oscilloscope model.

To recall a waveform file on most oscilloscopes, follow these steps:

1. In the oscilloscope menu bar, select File> Reference Waveforms> Reference Setup, File> Reference Waveform Controls, or File> Recall. If the oscilloscope is in the Button mode, select the Ref or Recall button.

Ref1 is the default memory location to recall a waveform file. View the Oscilloscope Reference Memory Setup menu.

2. Select the  button for Recall Ref1 from File.
3. Navigate to the C:\TekApplications\TDSJIT3v2\Examples\waveforms directory.

4. Select the j3clk1.wfm file, and then the  button.

The oscilloscope recalls the waveform file to reference memory and displays the waveform when the recall is complete.

5. The way you return to the application depends on the oscilloscope model. To return to the application, in the oscilloscope menu bar, select App> Restore Application or select the  button. View how to return to the application.

To recall a waveform file on TDS5000B oscilloscopes, follow these steps:

1. Select File> Recall. The Recall dialog box appears.
2. In the left side of the dialog box, select the Waveform icon.
3. Select Ref1, Ref2, Ref3, or Ref4 as the Destination option.
4. Browse to select the waveform to recall.
5. Select the Recall button. The oscilloscope recalls and activates the Reference Waveform control window.
6. Select On to display the waveform.
7. Return to the application.

Note: The screen capture is from a TDS7000 oscilloscope. There are differences in the menu on other oscilloscope models.

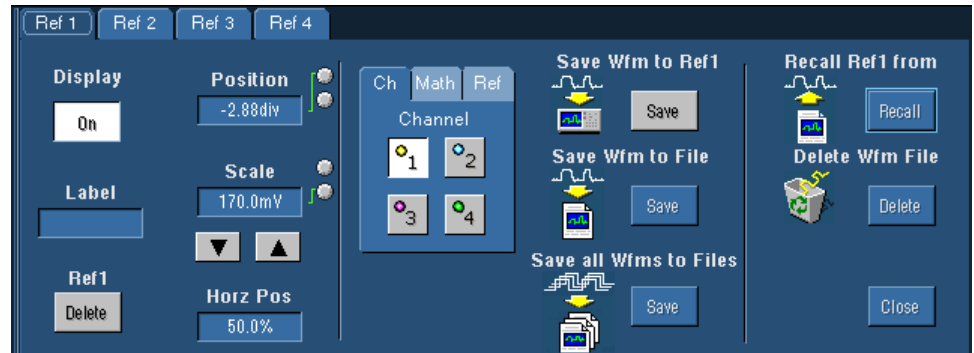

Figure 57: Oscilloscope Reference Memory options

Taking a Clock Period Measurement

In this lesson, you will learn how to use the application to take a Clock Period measurement and view the results. This lesson teaches you how to do the following tasks:



- Select a waveform source, and then a measurement
- Configure a measurement
- Take measurements
- View the measurement results as statistics
- View the results as various plots, such as Histogram
- Stop the application
- Return to the application

To perform these lessons, the application must be installed and enabled on the oscilloscope. See Installation.

Setting Up a Period Measurement

To set up the application to take a Clock Period measurement, follow these steps:

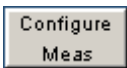
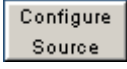
1. To set the TDSJIT3 v2 application to default values, select File> Default Setup. This is not necessary if you just started the application.
If you just started the application and the Jitter Wizard displays, select the Cancel button.
2. If necessary, select Measurements> Select> Clock. The Measurement Select menu appears with the Clock measurement buttons in the Add Measurement area.
3. Select Ref1 from the pop-up list of Select Source Clock options.
4. Select the Period button in the Add Measurement area. The application shows the selection in the Measurement and Sources area on the right side of the display. View the Measurements Select menu.

5. Select the  button. This lesson uses these default settings. View the Configure Measurement menu.
6. Select the  button, and then the Ref Levels tab. The Measurements Configure Source Ref Levels Menu appears.
7. Select the  command button. The application automatically calculates the appropriate reference voltage level values. View the reference voltage level values as calculated by the application.

Note: Step 7 is optional. The application automatically updates the reference voltage levels for sources where the Autoset option is set when you start sequencing the oscilloscope to take measurements. The Update step is included to show you what levels are selected in this lesson.

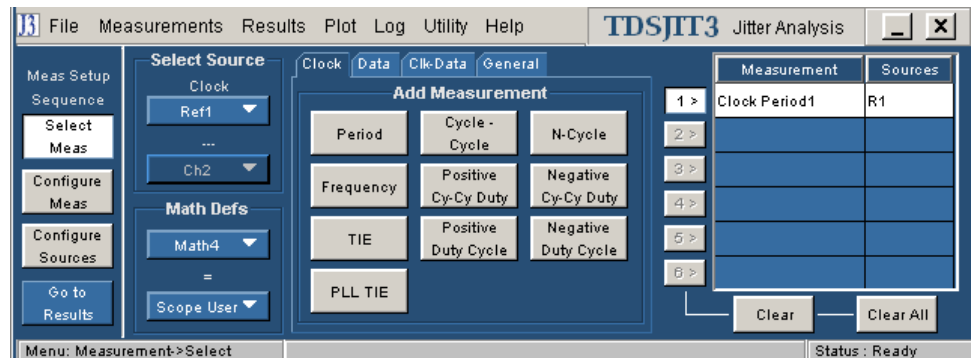

Figure 58: Clock Period measurement selected

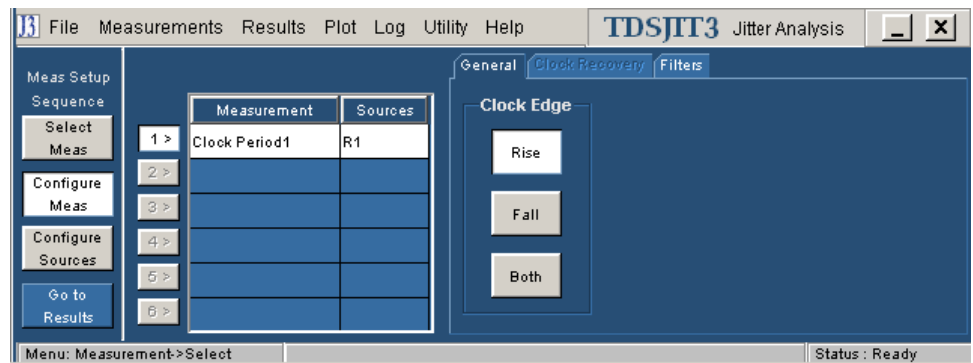

Figure 59: Configuration of a Period measurement

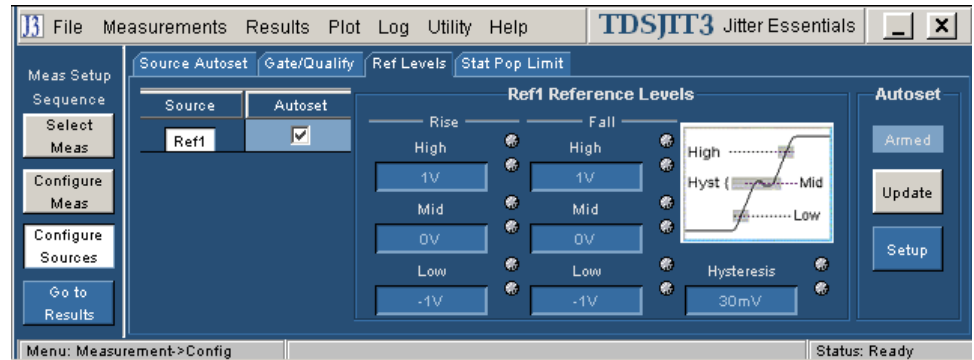

Figure 60: Configure Sources Ref Levels before an Autoset

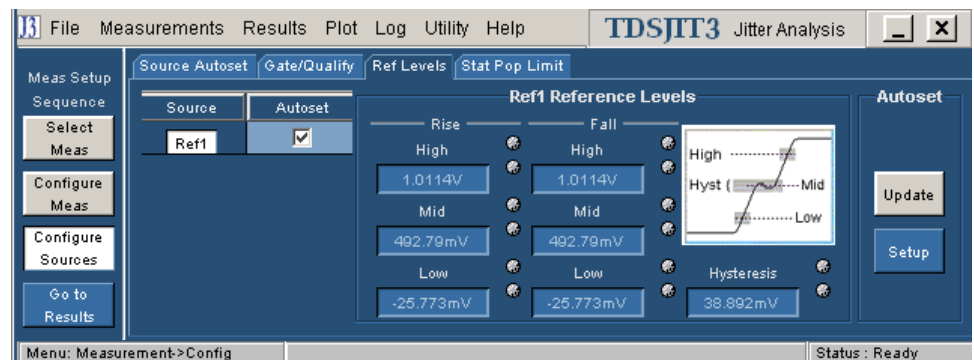
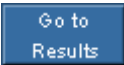



Figure 61: Configure Sources Ref Levels after an autoset

Taking a Period Measurement and Viewing Statistical Results

To take Clock Period measurements and view the results as statistics, follow these steps:

1. Select the  button. The All Statistics Results menu and the Control Panel appear.
2. Select the  Single command button in the Control Panel.

The application displays the results as statistics. View the results of a Clock Period measurement.

One-by-one, select the other statistical results tabs. View the Min/Max and Mean/Std. Dev. the statistical results menus.

Note: The TIE: RjDj - BER tab is for TDSJIT3 v2 Advanced only.

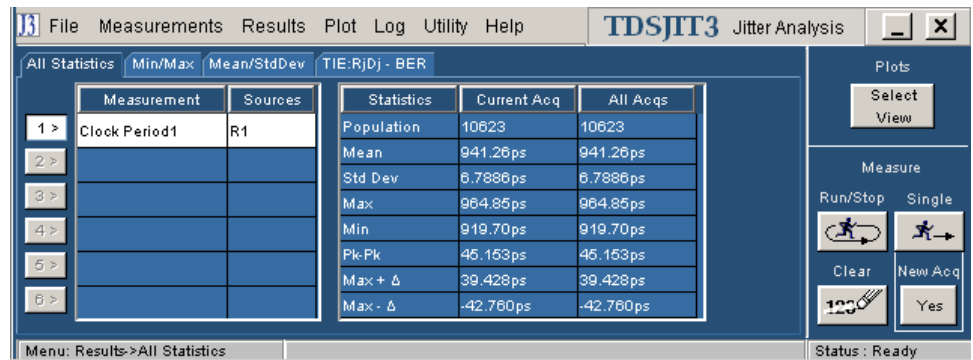

Figure 62: Statistical results for a Clock Period measurement

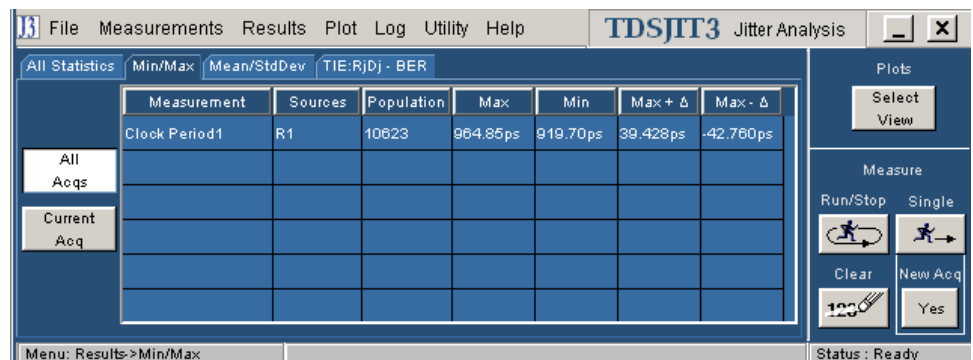

Figure 63: Min/Max statistical results for a Clock Period measurement

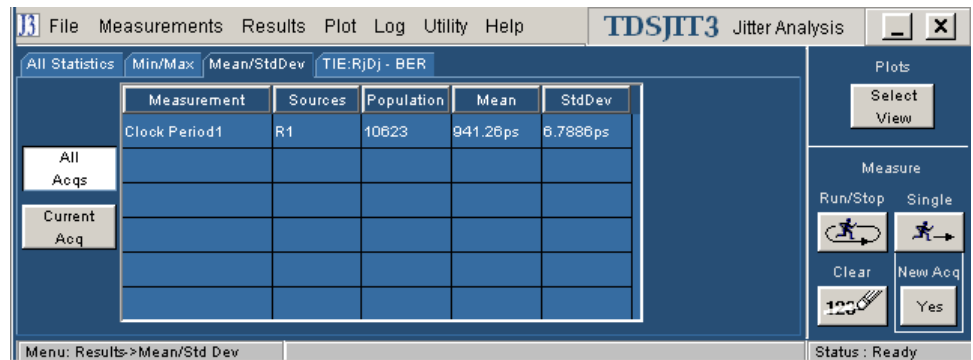

Figure 64: Mean/Std. Dev statistical results for a Clock Period measurement

Viewing a Period Measurement as Plots

To view the results as a plot, follow these steps:

1. Select Plot> Create. View the Plot Create menu.

2. Select the **Histogram** button. The application displays the results as a Histogram plot in the upper half of the screen. View the results as a Histogram plot.
3. One-by-one, select other plot menu buttons, such as the **Time Trend**, or **Spectrum** buttons. View the results as a Time Trend plot, or a Spectrum plot.

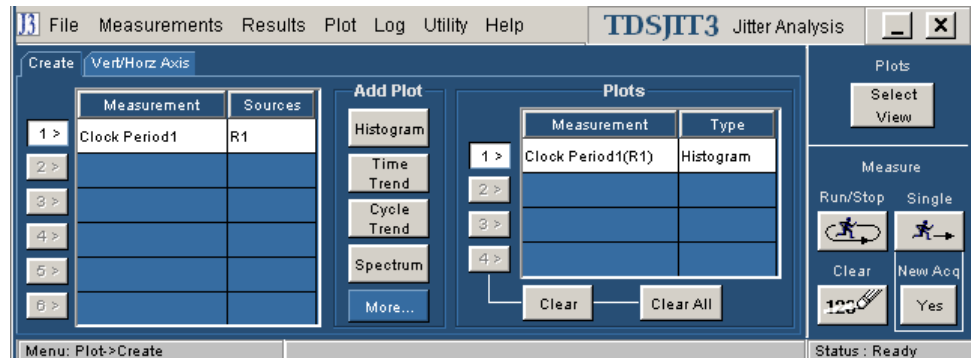

Figure 65: Create plots of results

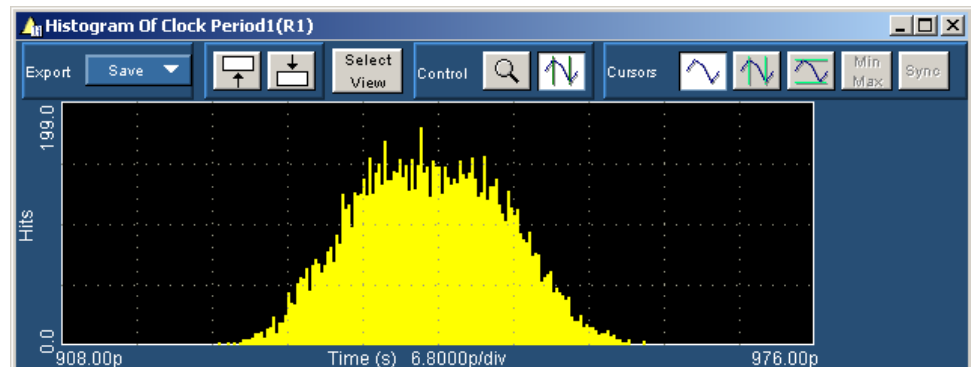

Figure 66: Results as a Histogram plot

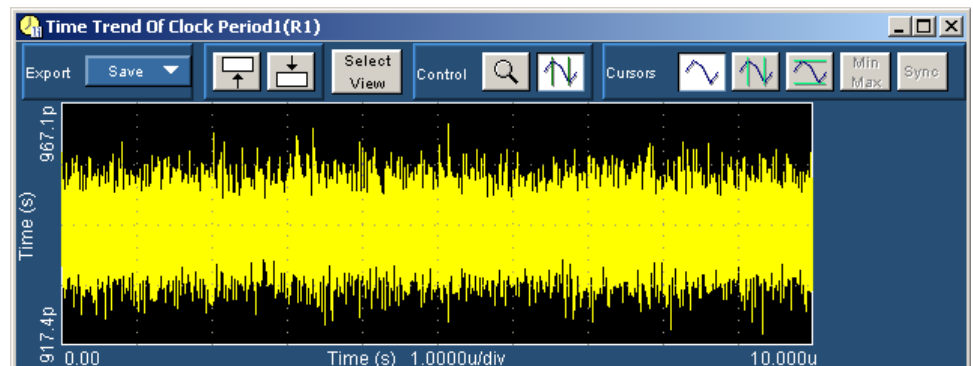
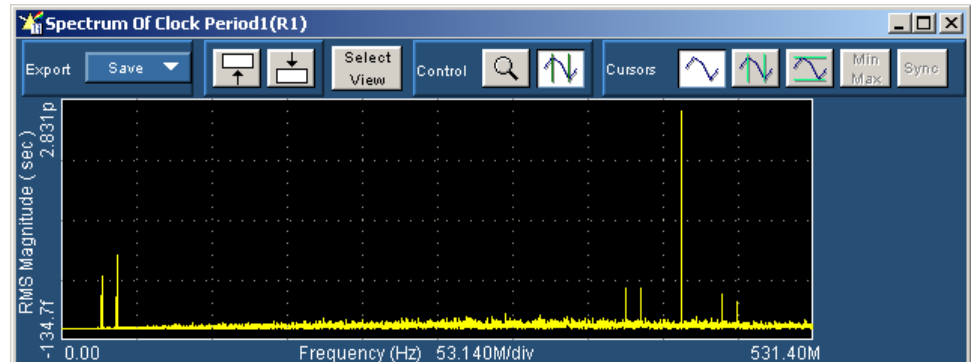

Figure 67: Results as a Time Trend plot**Figure 68: Results as a Spectrum plot**

Ending a Tutorial Lesson

If you need more than one session to complete the tutorial lessons, you can stop the tutorial and return to it another time.

Note: The purpose of this tutorial is to familiarize you with the basic functions of the application and menus.

To save the application setup and stop your session, refer to Saving a Setup File and to Exiting the Application.

To return to the tutorial setup, you can start the application, and then recall the saved setup. To recall the application setup, refer to Recalling a Saved Setup File.

Taking a Clock-to-Output Time Measurement

In this lesson, you will learn how to use the application to take a Clock-to-Output Time measurement. This lesson teaches you how to do the following tasks:

- Set up and take a Clock-to-Output Time measurement (requires two waveforms)
- View summaries of the measurement setup
- Log statistical results to a .csv file
- View a .csv file in a spreadsheet program
- Log data points for a snapshot of the measurement to a .csv file
- Log worst case waveforms to .wfm files

Setting Up and Taking a Clock-to-Output Time Measurement

To set up and take a Clock-to-Output Time measurement, follow these steps:

1. Recall the j3dat1.wfm file to the Ref2 memory location in the oscilloscope. Refer to the Recalling a Waveform File topic except select the Ref2 tab and then recall the waveform.

The j3clk1.wfm file is already recalled to Ref1 from the previous lesson.

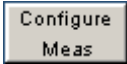
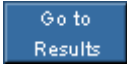
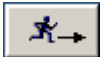
2. Return to the application.
3. Select Measurements> Select> Clk-Data.
4. Select the  button to remove all the measurements.
5. Select Ref1 as the Clock Source and Ref2 as the Data Source.
6. Select the Clock-Out button. View the Measurements Select menu.
7. Select the  button. This lesson uses these default settings. View the Configure Measurement menu.
8. Select the  button.
9. Select the  button. View the results of a Clock-to-Output Time measurement as statistics.
The application automatically updates the reference voltage levels for sources where the Autoset option is set when you start sequencing the oscilloscope to take measurements.
10. To see the calculated Ref2 values, select Measurements> Configure Sources> Ref Levels and then the Ref2 Source button in the Source table. View the Configure Source Ref Levels menu.
11. You can view various summary menus that show measurement settings. To do so, select Measurements> Summary of> Measurements. View the summary menu.
12. Select each of the other measurement summary menu tabs. View the summary of the reference voltage levels.

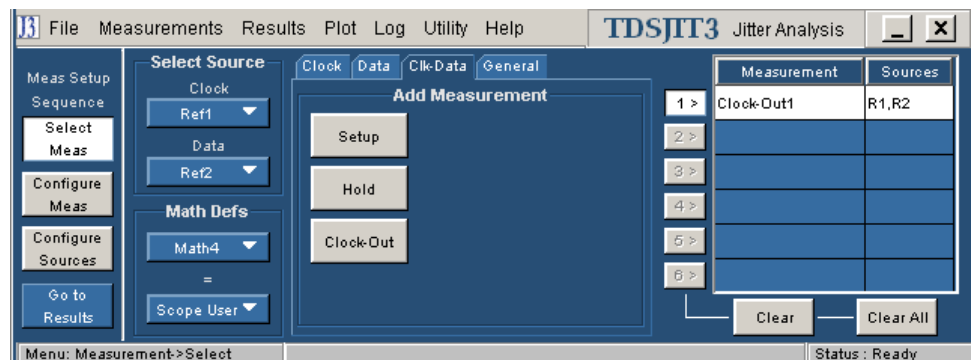

Figure 69: Clock-to-Output measurement selected

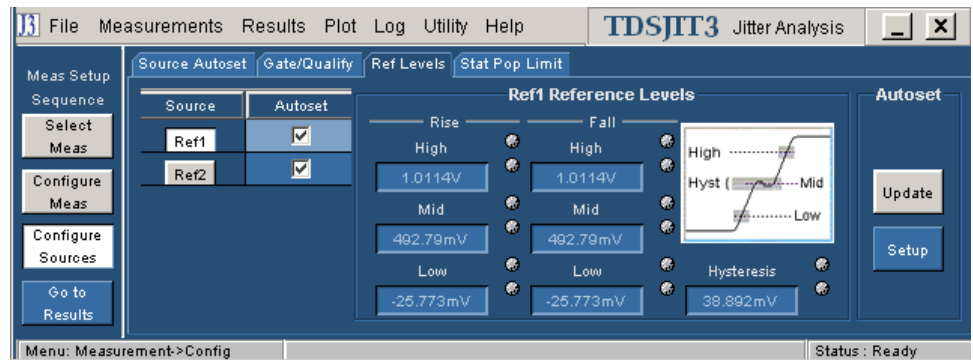

Figure 70: Configuration of a Clock-to-Output measurement

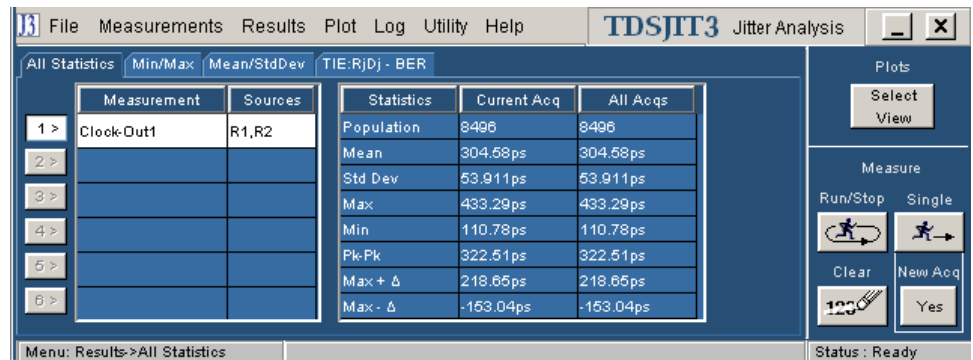

Figure 71: Statistical results for a Clock-to-Output measurement

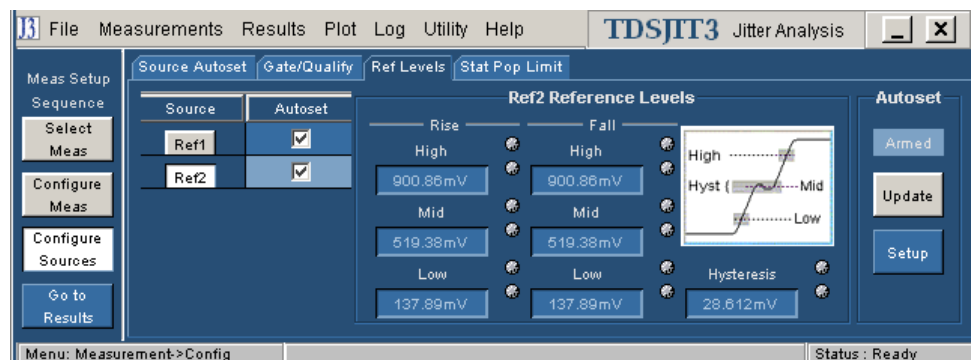

Figure 72: Configure Sources Ref Levels for a Clock-to-Output measurement

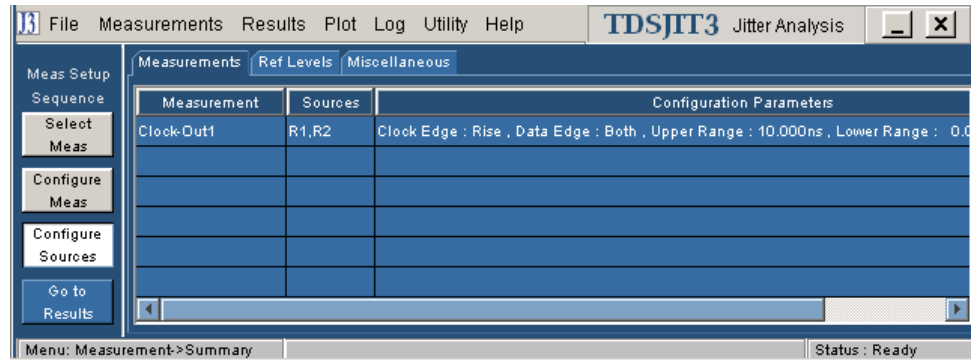

Figure 73: Measurements Summary for a Clock-to-Output measurement

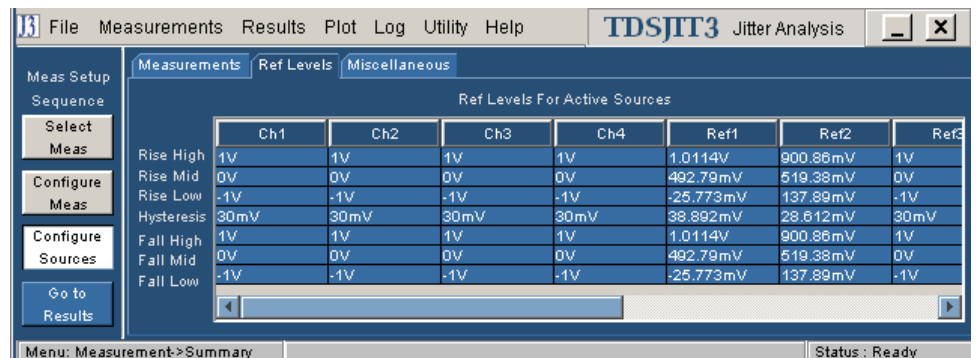
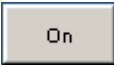

Figure 74: Ref Levels Summary for a Clock-to-Output measurement

Logging Statistics to a .CSV File

To log statistics to a .csv file, follow these steps:

1. Select Log> Statistics. The Log Statistics menu appears.

2. Select the  button. The Log File Name dialog appears.

3. Select a unique file name that is not listed in the browser window to start a new file, such as appending your initials to the stats.csv file name. This ensures that the file is empty when logging starts.

4. Select the  button. The file name menu closes and the Log Statistics function is enabled.

5. Select any menu from the Results drop down list to access the Control Panel.

6. Select the  button.

7. Launch the Windows Explorer.

8. Navigate to the stats<your initials>.csv file. View the path to the log statistics file.
9. Copy the file, and move it to a PC where you can open it with a spreadsheet program. View the stats.csv file in a spreadsheet program.

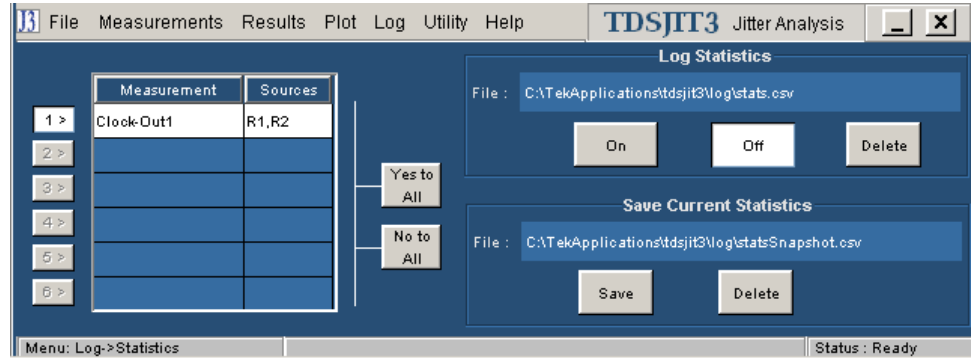

Figure 75: Log Statistics for a Clock-to-Output measurement

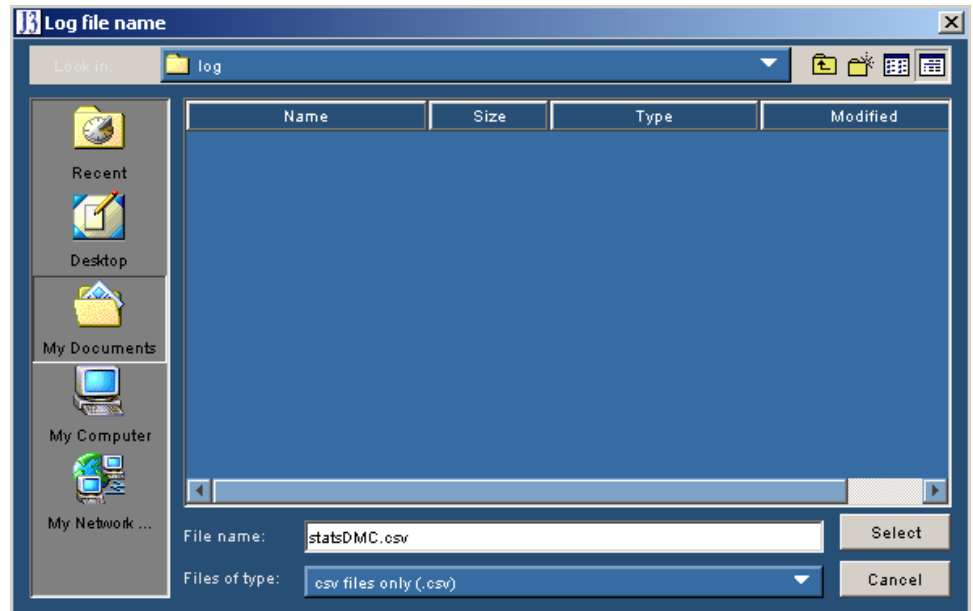

Figure 76: Log File Name dialog

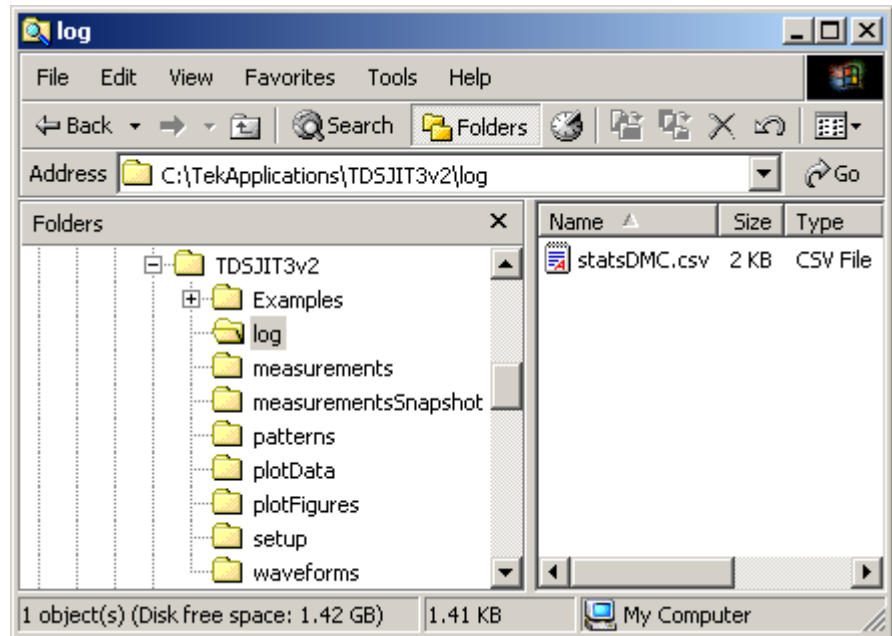

Figure 77: Path to the stats.csv log file

TDSJIT3 Version 1, Thu Mar 11 13:27:03 PST 2004

Measurements -

Measurment Sources: 1 Clock-Out R1 - R2 Configuration Parameters: Clock Edge Data Edge Upper Rai Lower Range : 0.00

Source Ref Levels -

Ref Levels	Ch1	Ch2	Ch3	Ch4	Ref1	Ref2	Ref3	Ref4	Math1	Math2	Math3
Rise High	1V	1V	1V	1V	1.0114V	900.86mV	1V	1V	1V	1V	1V
Rise Mid	0V	0V	0V	0V	492.79mV	519.38mV	0V	0V	0V	0V	0V
Rise Low	-1V	-1V	-1V	-1V	-25.773mV	137.89mV	-1V	-1V	-1V	-1V	-1V
Hysteresis	30mV	30mV	30mV	30mV	38.892mV	28.612mV	30mV	30mV	30mV	30mV	30mV
Fall High	1V	1V	1V	1V	1.0114V	900.86mV	1V	1V	1V	1V	1V
Fall Mid	0V	0V	0V	0V	492.79mV	519.38mV	0V	0V	0V	0V	0V
Fall Low	-1V	-1V	-1V	-1V	-25.773mV	137.89mV	-1V	-1V	-1V	-1V	-1V

Miscellaneous -

State	Gating	Source Qu	Pop Limit
Off	Off	Off	Off
-	-	Ch4	-
-	-	-	1000



Statistics -

Acq#	Time	TOD1(s)						
		Population Mean	Std Dev	Max	Min	Pk-Pk	Max + Del	Max - Delta
1	13:27:03	8496	3.05E-10	5.39E-11	4.33E-10	1.11E-10	3.23E-10	2.19E-10 -1.53E-10
Total	13:27:03	16992	3.05E-10	5.39E-11	4.33E-10	1.11E-10	3.23E-10	2.19E-10 -1.53E-10

Figure 78: Viewing statistics in a spreadsheet program

Logging Data Points as a Measurement Snapshot to a .CSV File

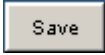
To log the data points for a snapshot of a measurement as a .csv file, follow these steps:

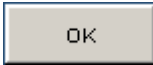
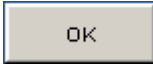
1. Select the  button.
2. Select Log> Measurements> Config. The Log Measurement Configure menu appears.
3. Select the  button. The Save Current Measurements dialog box appears.
4. Select the  icon to create a new directory. The Input Directory Name dialog box appears.
5. Enter "Tutorial" as the directory name. View the Input Directory Name dialog box.
6. This ensures that the application does not overwrite files with the same name that you may want to save in the default folder.
7. Select the  button. View the Save Current Measurements dialog box.
8. Select the  button again.
9. The application writes information to one file for each measurement on the oscilloscope. If a file with the same name exists, the application appends information to it.
10. Launch the Windows Explorer.
11. Navigate to the TCO1R1R2.csv file. View the path to the TCO1R1R2.csv file.
12. Copy the file, and move it to a PC where you can open it with a spreadsheet program. View the TCO1R1R2.csv file in a spreadsheet program.

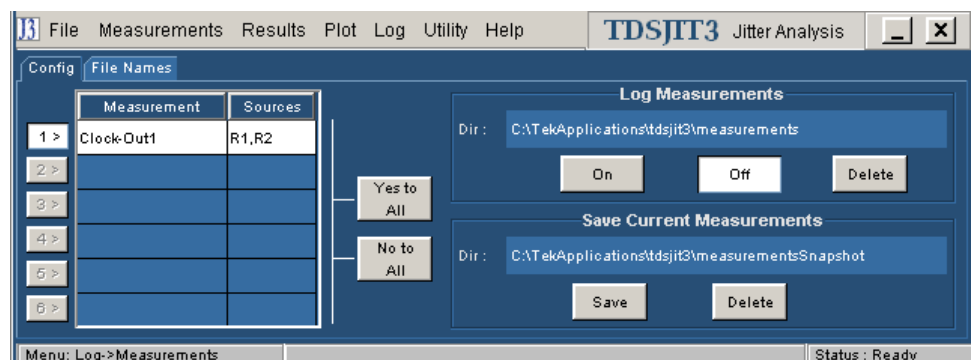

Figure 79: Log Measurement /configure menu for a Clock-to-Output measurement

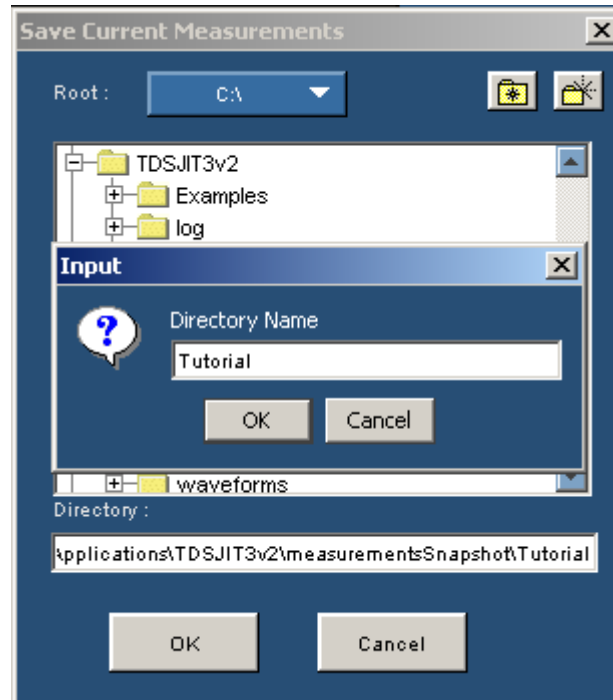

Figure 80: Input Directory Name dialog box

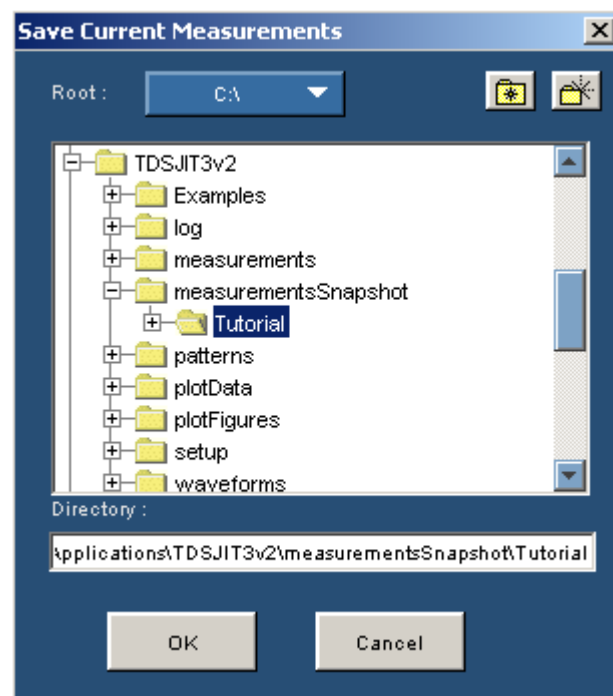

Figure 81: Save Current Measurements dialog box

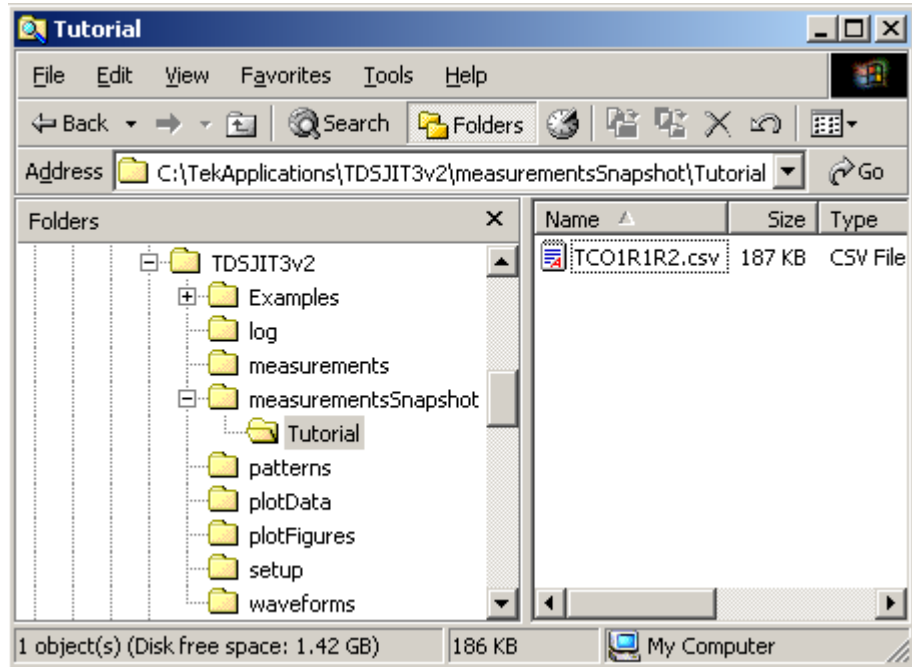

Figure 82: Path to the TC01R1R2.csv log file

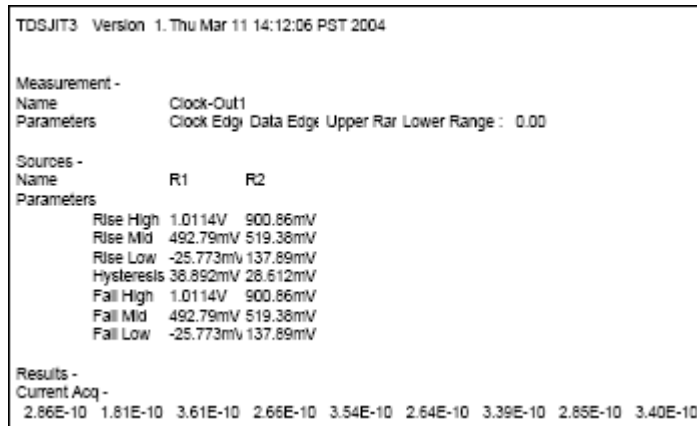

Figure 83: Viewing a data log file in a spreadsheet program

Logging Worst Case Waveforms to .WFM Files



To log the worst case waveforms as .wfm files, follow these steps:

1. Select Log> Worst Case Waveforms> Config. The Log Worst Case Waveforms Configure menu appears.

2. Select the button. The Log Worst Case Waveforms browser appears.

3. Create a new folder and name it Tutorial. To do so, refer to steps 3 and 4 in the previous procedure.

This ensures that the application does not overwrite files with the same name that you may want to save in the default folder. View the Log Worst Case waveforms dialog box.

4. Select the  button.
5. Select any menu from the Results drop down list to access the Control Panel.
6. Select the  button.

The application writes information to a maximum value file and to a minimum value file for each measurement and input channel. There are four files written for the two channel measurement Clock-to-Output. If a file with the same name exists, the application appends information to it.

7. Launch the Windows Explorer.
8. Navigate to the worst case waveform files for the Clock-to-Output measurement. View the path to the .wfm files for the Clock-to-Output measurement.

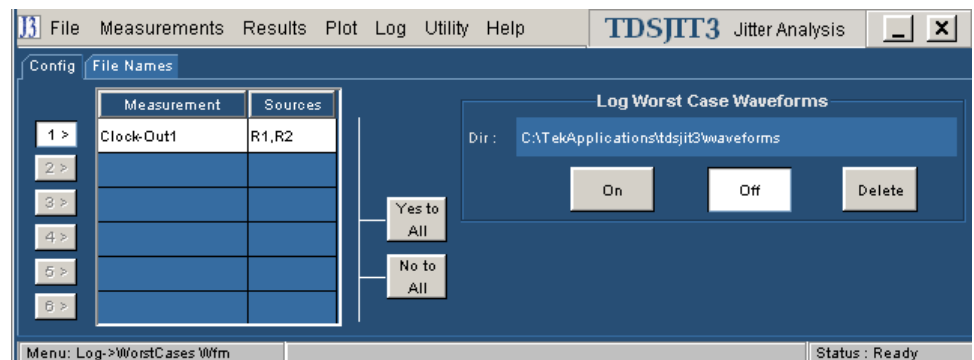

Figure 84: Log Worst Case Waveforms configuration for a Clock-to-Output measurement

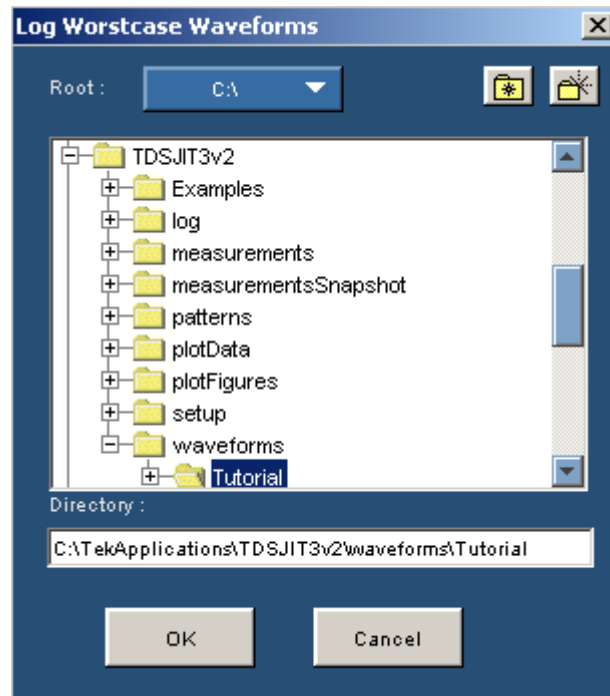

Figure 85: Log Worst Case Waveforms dialog

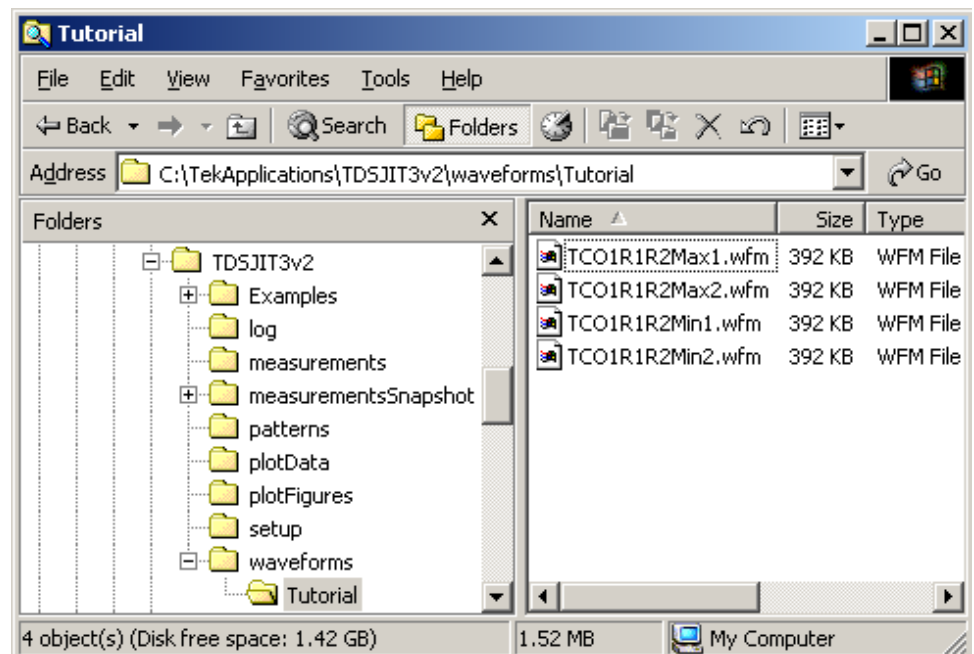

Figure 86: Path to the worse case .wfm log files

Lessons Learned

You should now be familiar with the basic functions of the TDSJIT3 v2 application and menus, and understand how to do the following tasks:

- Set up the application
- Take single waveform and two waveform measurements
- View summaries of the measurement setup
- View the results as statistics and as plots
- Log statistics to a .csv file
- View a .csv file in a spreadsheet program
- Log data points for a snapshot of a measurement to a .csv file
- Log worst case waveforms to .wfm files
- Exit and return to the application by saving and recalling setup files

Note: You can use the Jitter Wizard to quickly setup and achieve results for many measurements that do not require more advanced configuration. Refer to the following groups of topics for information on the common and advanced features:

- Operating Basics
- Application Examples
- GPIB Protocol

Application Examples

These simplified application examples highlight the TDSJIT3 v2 Advanced measurements and give you ideas on how to use the application to solve your own test problems. The application includes the following waveform files you can recall to a reference memory to try out each example:

- EXAMPLE-R1.wfm (data signal)
- EXAMPLE-R2.wfm (data signal)

Note: You must have the TDSJIT3 v2 application installed and enabled on the oscilloscope. For information, see Installation.

Requirements:

- TDS/CSA7000 series oscilloscope or TDS6000 series oscilloscope
- TDSJIT3 v2 Jitter Analysis software

Note: If your oscilloscope setup includes a second monitor, you can select and drag the title bar of the online help window to position it in the second monitor. This allows you to display these application examples in the second monitor, and still view the waveform (or a plot) and the TDSJIT3 v2 measurement results on the oscilloscope.

Set the oscilloscope controls to default settings.

Recall Default Settings

If you want to work through these examples on the waveforms included with the application, the results will match those shown in these topics. To ensure that your results match the results shown in these exercises, you need to recall the default settings to the oscilloscope. To do so, follow these steps:

1. Push the DEFAULT SETUP front-panel button to set the oscilloscope to the default factory settings.
2. Push the individual CH1, CH2, CH3, and CH4 buttons as needed to remove active waveforms from the display.

Note: The TDSJIT3 v2 application recalls its default settings when you start the application.

Recall a Waveform and Start the Application

Recall the appropriate file (such as the EXAMPLE-R1.wfm file) to the Ref1 memory location on the oscilloscope. For information on how to do so, refer to the Recalling a Waveform File topic in the Tutorial.

Then, start the application.

Note: This is the basic starting point for most jitter measurements. The main difference is that measurements are usually taken from "live" channel waveforms.

Application Example 1: Spectral Analysis

This example shows a simple method to find jitter sources using spectral analysis, a powerful tool for diagnosing problems and allowing a method to quantify design changes made to improve system performance.

The first example demonstrates the following tasks:

- How to measure the Data Period and Time Interval Error of a data signal
- How to determine the pattern repeat interval
- How to measure Rj/Dj
- How to determine jitter components using spectral analysis

Set Up and Take Measurements for Example 1

To set up this example and take measurements, follow these steps:

1. To set the TDSJIT3 v2 application to default values, select File> Default Setup. This is not necessary if you just started the application.

If you just started the application, close the Jitter Wizard menu to reveal the Measurement Select menu.

Since this is a data signal, you need to take Data measurements. This distinction allows the software to improve the handling of different data encoding formats, such as 8B10B.

2. If necessary, select Measurements> Select> Data. The Measurement Select menu appears with the Data measurement buttons in the Add Measurement area.
3. Select Ref1 from the pop-up list of Select Source Data options.
4. Select the Period button in the Add Measurement area, and then the TIE button.
5. Select the Go To Results button. The All Statistics results menu appears.
6. Select the Single button to start sequencing and take measurements. View the results.

With "live" channel waveforms, you can use the Run/Stop button to reacquire data and repeat the measurement process for each new acquisition.

At this point, you can see that the Data Period is 399.99 ps, or a 2.5 Gbps waveform.

Now you can use a repeating pattern with a known pattern length to quickly determine accurate Rj/Dj values. To do so, refer to the Approximate Pattern Length Measured with Cursors topic.

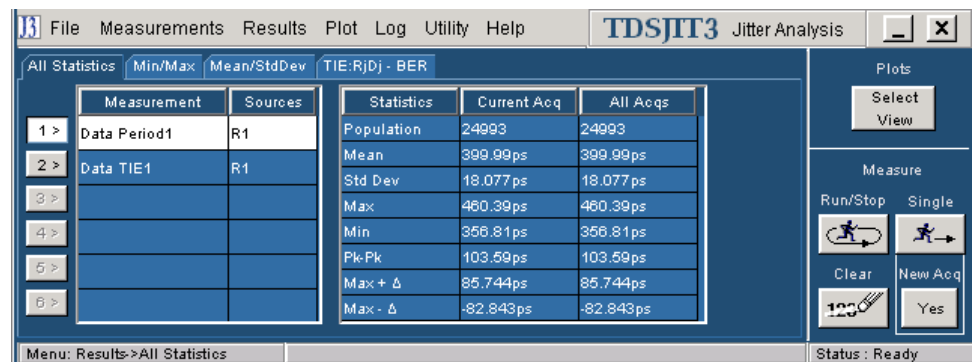

Figure 87: Data Period results for example 1

Approximate Pattern Length Measured with Cursors

A repeating pattern with a known pattern length allows you to use spectral analysis to identify jitter components.

Since the data period is close to 400 ps, you can calculate the pattern length if you can determine the time between repeats. To determine the time between repeats, follow these steps:

1. Push the front panel Horizontal Zoom button.
2. Turn the Factor multipurpose knob to adjust the horizontal zoom factor until a repeating pattern appears.

A zoom factor of 20 shows that there is a pattern, and at 50 the pattern becomes clear. At a zoom factor of 100, the pattern duration can easily be measured with cursors.

3. Push the front panel Cursors button and adjust the cursors to the beginning and end of one of the repeats.
4. Push the front panel Fine button and adjust the cursors so they overlap the midpoint crossings of the falling edges of the long sequence of ones followed by a long sequence of zeros. View the Pattern Length measured with cursors.
5. The cursors show a Δt of 50.8 ns. With a data period of 400 ps, you can use the following equation to calculate the number of bits in each repeat:

$$\text{Nbits} = \Delta t / \text{UI}$$

With the values used here, $50.8\text{E-}9 / 400\text{E-}12 = 127$, the repeating pattern is 127 bits. In this case, the waveform is a capture of a PRBS 2^7-1 LVPECL signal operating at 2.5 Gbps.

Now that you know the length of the repeating pattern, you can measure the Rj/Dj and Tj @ BER of the waveform. To do so, refer to the Measuring Rj/Dj and Tj @ BER topic.

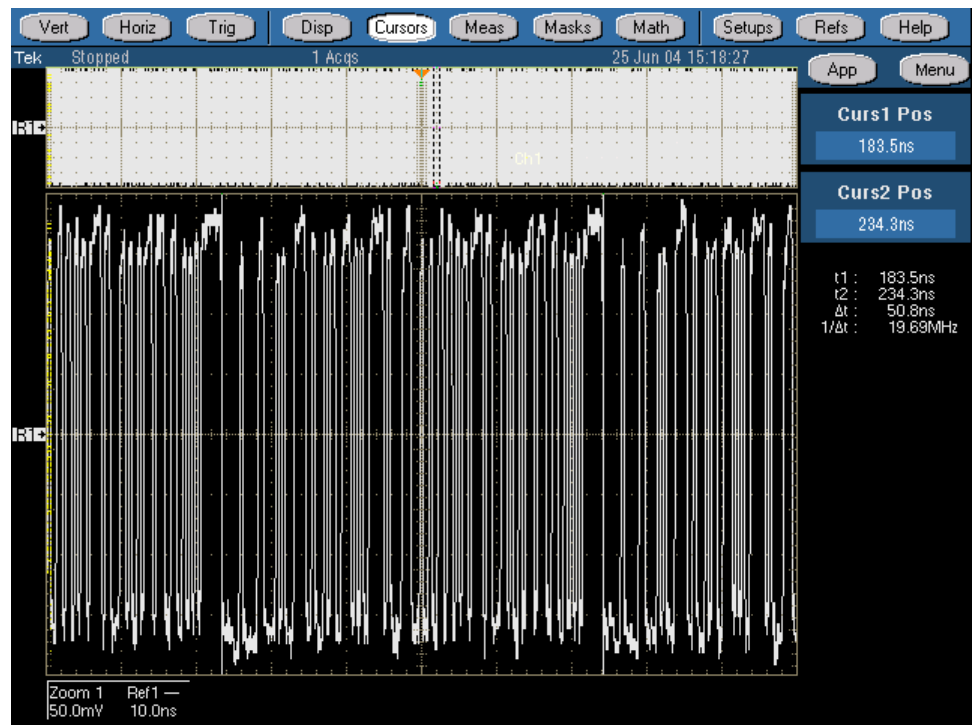

Figure 88: Pattern Length for example 1

Measuring Rj/Dj and Tj @ BER

You can measure the Rj/Dj of a signal with any TIE measurement. This includes clock and data measurements, and PLL measurements. The advantage of a PLL based measurement is that it excludes lower frequency jitter components from the results.

To measure the Rj/Dj of the waveform, follow these steps:

1. Select Measurements> Configure Meas> General.
2. Select the Data TIE1 measurement.
3. Set up the TIE: Rj/Dj options as follows:
 - a) Data Pattern Type is Repeating.
 - b) Pattern Length is 127.
 - c) Separation is On.
4. Select the Go To Results button, and then the RjDj tab.

The Rj/Dj results show the breakdown of the random and deterministic components within the composite TIE measurement.

Of the 25.63 ps Std Deviation and the 131.17 ps Peak-to-Peak values, 6.85 ps is random jitter, 20.35 ps is periodic jitter, and 89.92 ps is data dependent jitter. If you continued to measure the composite TIE on a live signal until the measured population was 1E12, the Peak-to-Peak result would approximate the $T_j @ BER$ value.

Now that you determined the amount of jitter, you need to find the source of jitter. One way to find the source is with spectral analysis. To do so, refer to the Using Spectral Analysis to Find Jitter Sources topic.

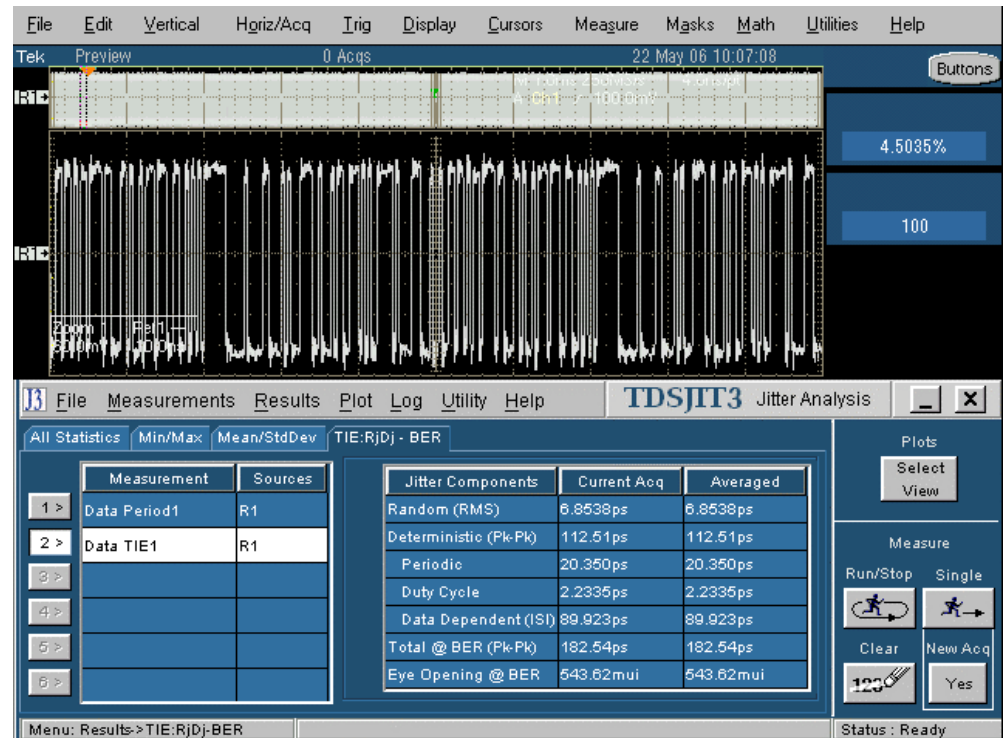

Figure 89: Rj/Dj results for example 1

Using Spectral Analysis to Find Jitter Sources

The designer needs to know more than just the amounts of jitter. The designer also needs to locate, quantify, and then determine the cause of jitter to improve system performance.

One way to find the source is with spectral analysis. Not with spectral analysis of the original signal, but with spectral analysis of the composite jitter in the original signal. The TDSJIT3 application does this by treating the measurement array as a new sampled data set.

To view the spectral components of the jitter on this waveform, you need to create a spectral plot. To do so, follow these steps:

1. Select Plot> Create.
2. Select the Data TIE1 measurement, and then the Add Plot Spectrum button. A plot displays.
3. You may need to select the Select View button to reposition the plot.
4. Carefully inspect the plot.

You will notice several spurs occur at regular intervals. This is normal for data waveforms. The spurs are caused by data dependent sources. Normally, the largest offender is inter-symbol interference (ISI). This is primarily due to the frequency dependent losses in transmission lines, but also can be affected by other factors, such as signal reflections.

5. Select the Zoom controls, and then use the Zoom tools to zoom in to the lower third of the Spectrum plot. You can see that there are a few spurs that are not regularly spaced. View the spurs.
6. Select the Cursor controls, and then use the Horizontal cursors tool to examine the spurs at 125 MHz and 250 MHz.

These two spurs alone contribute 1.8 ps and 1.5 ps jitter. This noise is from a nearby oscillator that is on the circuit board generating the test signal. The oscillator is injecting significant 125 MHz energy (and harmonics) into the 2.5 Gbps data signal. If faced with marginal compliance, this knowledge would allow a designer to quantify improvements made to reduce noise from this 125 MHz source.

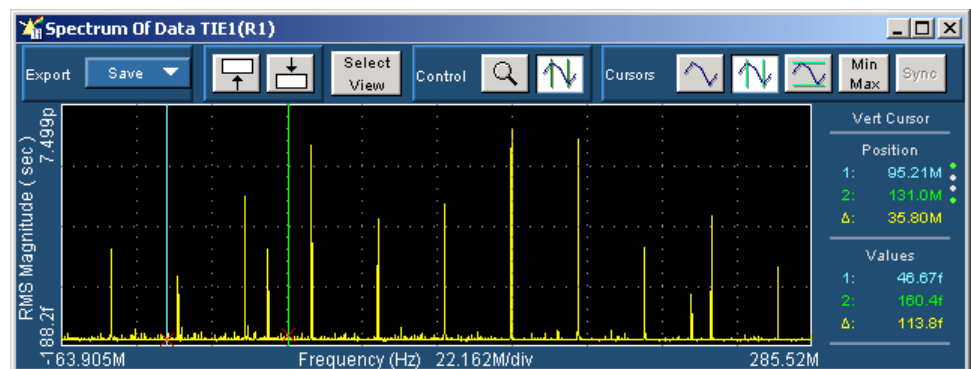

Figure 90: Spurs for example 1

Application Example 2: Trend Analysis

This example shows a simple way to find modulation extremes, a useful tool for diagnosing problems and evaluating oscillator performance under real world conditions.

The second example demonstrates the following tasks:

- How to measure the Data Period of a data signal
- How to determine the spread spectrum modulation amplitude

Set Up and Take Measurements for Example 2

To set up this example and take measurements, follow these steps:

1. Recall the EXAMPLE-R2.wfm file to the Ref1 memory location on the oscilloscope. For information on how to do so, refer to the Recalling a Waveform File topic in the Tutorial.
2. To set the TDSJIT3 application to default values, select File> Default Setup. This is not necessary if you just started the application.

If you just started the application, close the Jitter Wizard menu to completely reveal the Measurement Select menu.

Since this is a data signal, you need to take Data measurements. This distinction allows the software to improve the handling of different data encoding formats, such as 8B10B.

3. If necessary, select Measurements> Select> Data. The Measurement Select menu appears with the Data measurement buttons in the Add Measurement area.
4. Select Ref1 from the pop-up list of Select Source Data options.
5. Select the Period button in the Add Measurement area.
6. Select the Configure Meas button, and then the Filters tab.
7. Set up the Filters options as follows:
8. Low Pass (F2) Filter Spec is set to 2nd Order.
9. Freq (2) is set to 1 MHz.
10. Select the Go To Results button. The All Statistics results menu appears.
11. Select the Single button to start sequencing and take measurements. View the results.

With "live" channel waveforms, you can use the Run/Stop button to continuously reacquire data and repeat the measurement process for each new acquisition.

You can directly compare the minimum and maximum data period values to your specification limits. In many situations, you may want to view the sequential effects of the modulation, especially when the modulation changes direction from downspread to upspread. One way to view the effects is to create a Time Trend plot of the period measurements. To do so, refer to the Using Trend Analysis to Find Jitter Amplitude and Anomalies topic.



Figure 91: Data Period results for example 2

Using Trend Analysis to Find Jitter Amplitude and Anomalies

To view the sequential effects of modulation (especially when it changes direction from downspread to upspread), you need to create a Time Trend plot. To do so, follow these steps:

1. Select Plot > Create.
2. Select the Data Period1 measurement, and then the Add Plot Time Trend button.

A plot displays that clearly shows the modulation profile. In this example, the modulation is from a triangular SSC source. View the plot.

You can use the plot analysis tools to further examine the modulation profile and find worst-case events.

3. Select the Cursor controls, and then the Vertical cursors tool.

There are several ways to move the cursors: touch and drag (touch screen), click and drag (mouse), and general purpose knobs. You can also use the Min-Max cursor button to place the cursors on the minimum and maximum extremes.

4. Select the Min-Max button.

The application moves the cursors to the minimum and maximum periods in the acquisition. The cursor readout shows that the minimum period is 333.3 ps and the maximum period is 335.0 ps. This is the ideal 0.5% downspread for a 3 Gbps signal.

You can use the cursor synchronize and waveform zoom tools to conduct further analysis.

5. Use the plot position tool to reposition the Time Trend plot in the lower half of the display.
6. Select the Sync cursor tool. This places the oscilloscope primary cursors at the exact points where the two SSC profile extremes occur.
7. Select the Zoom controls, and then use the Zoom tools to examine more details of the waveform at the time of the minimum and maximum events.

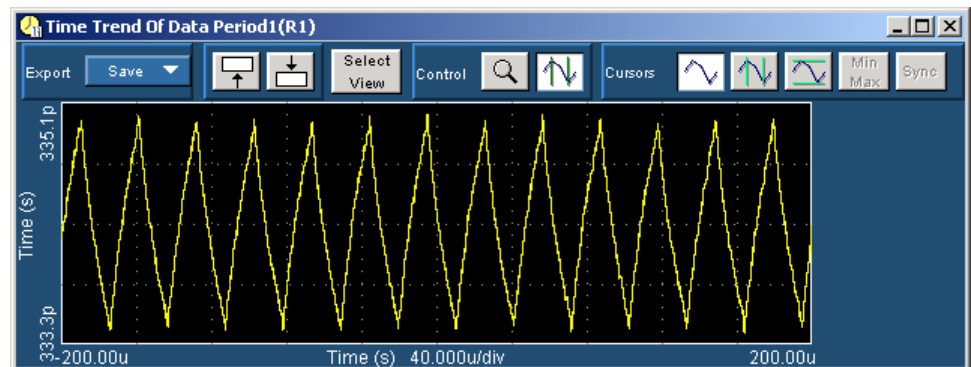

Figure 92: Time Trend plot for example 2

Algorithms

The TDSJIT3 v2 application can take timing measurements from one or two waveforms. The number of waveforms used by the application depends on the type of measurement being taken.

Oscilloscope Setup Guidelines

For all measurements, use the following guidelines to set up the oscilloscope:

- The signal is any channel, reference, or math waveform.
- The vertical scale for the waveform must be set so that the waveform does not exceed the vertical range of the oscilloscope.
- The sample rate must be set high enough to capture sufficient waveform detail and avoid aliasing.
- Longer record lengths increase measurement accuracy but the oscilloscope takes longer to measure each waveform.

Test Methodology

The application performs the measurement according to the following steps:

1. Imports the current waveform.
2. Checks that the reference voltage level plus or minus half the hysteresis are within the 2.5% to 97.5% range of the peak-to-peak waveform values.
3. Checks that there are a minimum number of edges in the waveform to calculate the measurement as follows:
 - Single edge: Rise Time, Fall Time
 - One edge pair: Pulse Width, High Time, Low Time
 - Two cycle-start edges: Period, Frequency, Duty Cycle
 - Three cycle-start edges: Cycle-to-Cycle, TIE, PLL TIE
 - Clock TIE and PLL TIE measurements require 500 edges for RjDj analysis (TDSJIT3 v2 Advanced only)
 - Data TIE, PLL TIE, and Clock-Data-TIE measurements require 100 repeated patterns or 10 K edges of an arbitrary pattern (TDSJIT3 v2 Advanced only)
 - $2N + 1$ cycle-start edges: N-Cycle
 - Two edges on each of two waveforms: Skew, Crossover Voltage (TDSJIT3 v2 Advanced only)
4. Performs the measurement.
5. Displays the results as statistics. You can also log the results or data points to a .csv file.
6. Displays the results as a plot if set up.

Timing Measurements

All timing measurements are based on the time locations of edges within each acquisition. Edge conditions are defined in the setup menu of each timing measurement. T_n represents the acquisition edge times where n is an index between 1 and the number of edges in the acquisition.

The "i" and "j" represent dissimilar acquisition indices. Dissimilar acquisition indices occur when the correlation between clock edges and a data transitions are not one-to-one.

Rj/Dj Measurement (TDSJIT3 v2 Advanced Only)

The Rj/Dj measurement calculates the deterministic and random components of a jitter. The jitter is obtained from the TIE measurements. Rj is the random jitter. It is assumed to be Gaussian and has a flat spectrum. The Rj measurement calculates the standard deviation of the random jitter. Dj is the deterministic jitter. It is predictable and can be generated consistently given known circumstances. Dj has a spectrum of impulses when the data signal has a repeating pattern. The Dj measurement calculates the peak-to-peak value of the deterministic jitter. Tj is the total jitter, which is composed of Dj and Rj. The Tj measurement calculates the peak-to-peak value of the total jitter at the specified BER.

Two approaches are supported. The first method is a spectrum analysis based approach (default) when the data pattern is repetitive. A clock waveform is always repetitive. Other repetitive testing data patterns are used, such as the K28.5 data pattern.

The second R/Dj separation method is an arbitrary pattern analysis based approach when the data pattern is not necessarily repetitive. For a long PRBS data pattern, the data is virtually non-repetitive within a single acquisition.

Spectrum Analysis Based Rj/Dj Separation

Deterministic Jitter (Dj) has a spectrum of equally-spaced impulses when the data signal has a repeating pattern. To obtain measurements of Dj and Rj, the application distinguishes the deterministic impulses from the noise floor in the spectrum of total jitter.

The application calculates Rj measurement using the following equation:

$$Rj = \text{Standard deviation}(\text{noise floor of jitter spectrum})$$

The application calculates the Dj measurement using the following equation:

$$Dj = \text{Max}(Dj^{Time}) - \text{Min}(Dj^{Time})$$

Where: Dj is the deterministic jitter.

Dj^{Time} is the time domain record of the Dj component of jitter obtained by performing an inverse FFT of the Dj components of the TIE spectrum.

- Dj is composed of ISI, DCD and Pj: ISI is the Inter-Symbol Interference. It is also called DDj (Data Dependent Jitter). The ISI measurement calculates the peak-to-peak value of the ISI.

- DCD is Duty Cycle Distortion. It is the difference in the mean pulse width of positive pulse width compared to the mean pulse width of negative pulse width. The DCD measurement calculates the peak-to-peak value of the DCD.
- Pj is periodic jitter. The Pj measurement calculates the peak-to-peak value of the Pj.

For a data signal with a repetitive data pattern, Dj has a spectrum of impulses. All impulses due to DDJ ISI+DCD components must appear at multiples of f_o/N where f_o is the data bit rate and N is the data pattern length. Any remaining impulses are due to Pj.

The application distinguishes the impulses that appear due to ISI+DCD and impulses due to Pj.

The application calculates Pj measurement using the following equation:

$$Pj = \text{Max}(Pj^{Time}) - \text{Min}(Pj^{Time})$$

Where: Pj is the deterministic jitter.

Pj^{Time} is the time domain record of Pj obtained by performing an inverse FFT on Pj components of the TIE spectrum.

The application calculates the time domain histogram of ISI+DCD for the rising edges and for the falling edges respectively.

The application calculates ISI measurement using the following equation:

$$ISI = \left(\text{Max}(H^{Rise}) - \text{Min}(H^{Rise}) + \text{Max}(H^{Fall}) - \text{Min}(H^{Fall}) \right) / 2$$

$$DCD = \left| \text{Mean}(H^{Rise}) - \text{Mean}(H^{Fall}) \right|$$

Where: ISI is the inter-symbol interference.

DCD is the duty cycle distortion.

H^{Rise} is the time domain histogram of ISI+DCD for the rising edges.

H^{Fall} is the time domain histogram of ISI+DCD for the falling edges.

Arbitrary Pattern Analysis Based Rj/Dj Separation

When the data pattern is non-repeating, Pj still has a spectrum of impulses, while ISI+DCD no longer has a spectrum of impulses. Therefore, Dj no longer has a spectrum of impulses.

The ISI+DCD value is obtained through the arbitrary data pattern analysis method which is based on the assumption that any given bit is affected by a finite number of preceding bits. By averaging all events where the current bit is preceded by a particular bit sequence, for example the current bit is preceded by the bit sequence 1001101, the ISI+DCD with such a pattern is obtained since PJ and RJ are not correlated to a particular data sequence and thus are averaged out.

If each bit is assumed to be affected by N preceding bits, there are a total of 2N possible data sequences. The sequence length N is a configurable parameter. To get statistical sound average values, a population limit is the other configurable parameter which prevents using an average value without enough population.

Only ISI+DCD values obtained from data sequences with a population above the limit are used to calculate ISI+DCD values.

After each edge is associated with an ISI+DCD value, with known total jitter, the PJ+RJ value for each bit is then obtained by subtracting ISI+DCD from TJ.

Separation of ISI and DCD from ISI+DCD is the same as that in the spectrum based Rj/Dj separation method.

Pj and Rj is then separated from Pj+Rj and uses the spectrum analysis method. PJ has a spectrum of impulses, Rj has a flat spectrum. All the edges whose ISI+DCD can not be determined because of their associated data sequences have low populations and are treated as if there are no edges when performing Pj and Rj separation.

The histogram of Dj is a convolution of the histogram of ISI+DCD and the histogram of Pj.

All other aspects of the arbitrary pattern analysis based Rj/Dj separation are the same as those of the spectrum analysis based Rj/Dj separation.

BER and Tj Estimation (TDSJIT3 v2 Advanced Only)

The BER Estimation calculates the bit error rate curve and the eye opening for a given bit error rate. After the Rj/Dj separation, the recovered histogram of the total jitter can be computed. The recovered Tj histogram, when properly normalized, can be interpreted as the probability density function (PDF) of the Tj.

Integration of the PDF yields the CDF, which can then be used to create the bit error rate curve (bathtub curve). Based on the bathtub curve, the eye opening can be estimated for a given bit error rate.

The application calculates the recovered total jitter histogram using the following equation:

$$H^{Tj} = H^{Dj} \otimes H^{Rj}$$

Where: H^{Tj} is the recovered histogram of total jitter.

H^{Dj} is the histogram of Dj and is computed from the time record of Dj after the RjDj separation.

H^{Rj} is the histogram of Rj and is synthesized based on its Gaussian model after the RjDj separation.

The application calculates the eye opening at the specified BER using the following equation:

$$\text{Eye opening} = 1 - Tj/UI \text{ when } Tj \text{ is } < UI$$

$$\text{Eye opening} = 0 \text{ when } Tj \text{ is } = UI$$

Where: UI is the unit interval in seconds.

Effective Rj and Tj Estimation (TDSJIT3 v2 Advanced only)

Effective Rj and Dj is a way to define Rj and Dj to avoid instrument- or vendor-specific jitter separation models. This estimation method fits the Bathtub curve to

a theoretical model of R_j and D_j where R_j is assumed to have a Gaussian distribution, D_j is assumed to have a distribution of two Dirac impulses with the same height. Two point curve fitting at BER levels of 10^{-5} and 10^{-9} in Bathtub curve is implemented to get effective R_j and D_j . The Bathtub curve is obtained from the spectrum analysis based or the arbitrary pattern analysis based R_j/D_j separation methods.

Usually, the value of the effective R_j is greater than the value of R_j obtained from the spectrum analysis based or the arbitrary pattern analysis based R_j/D_j separation. The value of the effective D_j is less than that of its corresponding one.

After the effective R_j and D_j are obtained, the histogram of effective T_j can be calculated by a combination of the histogram of the effective R_j and the histogram of the effective D_j . Then the effective T_j and the effective eye opening can be computed in the same way described in the previous topic.

The detailed description is available from the T11 Web site.

Single Waveform Measurements

The application defines conditions for a single waveform to take the following measurements:

Table 42: Single waveform measurements

Clock		Data	General
Period	N-Cycle	Period	Rise Time
Frequency	Positive Cy-Cy Duty	Frequency	Fall Time
TIE	Negative Cy-Cy Duty	TIE	Positive Width
PLL TIE*	Positive Duty Cycle	PLL TIE*	Negative Width
Cycle-Cycle	Negative Duty Cycle		High Time
			Low Time
* TDSJIT3 v2 Advanced only.			

Clock Period Measurement

The Clock Period measurement calculates the duration of a cycle as defined by a start and a stop edge. Edges are defined by slope, threshold, and hysteresis.

The application calculates this measurement using the following equation:

$$P_n^{Clock} = T_{n+1} - T_n$$

Where: P_n^{Clock} is the clock period.

T is the VRefMid crossing time in the Cycle Start Edge direction

Clock Frequency Measurement

The Clock Frequency measurement calculates the inverse of the clock period for each cycle.

The application calculates this measurement using the following equation:

$$F_n^{Clock} = 1 / P_n^{Clock}$$

Where: F^{Clock} is the clock frequency.

P^{Clock} is the clock period measurement.

Clock TIE Measurement

The Clock TIE measurement calculates the difference in time between the specified clock edge on a sampled clock waveform to the corresponding edge on a recovered clock waveform with a constant frequency (zero jitter).

The application calculates this measurement using the following equation:

$$TIE_n^{Clock} = T_n^{Clock} - T_n'^{Clock}$$

Where: TIE^{Clock} is the clock time interval error.

T^{Clock} is the VRefMid crossing time for the specified clock edge.

T'^{Clock} is the recovered VRefMid crossing time by means of linear regression.

Clock PLL TIE Measurement (TDSJIT3 v2 Advanced Only)

The Clock PLL TIE measurement calculates the difference in time between the specified edges on a sampled clock waveform to the corresponding edge on a clock waveform calculated by means of a PLL. Low frequency TIE components that are within the loop bandwidth of the PLL are tracked by the PLL and thereby removed.

The application calculates this measurement using the following equation:

$$TIE_n^{Clock} = T_n^{Clock} - T_n'^{Clock}$$

Where: TIE_n^{Clock} is the clock time interval error.

T_n^{Clock} is the VRefMid crossing time for the specified clock edge.

$T_n'^{Clock}$ is the recovered VRefMid crossing time by means of a PLL. Data Period Measurement

The Data Period measurement calculates the duration of a cycle as defined by a start and a stop edge. Edges are defined by threshold, and hysteresis.

The application calculates this measurement using the following equation:

$$P_n^{Data} = (T_n^{Data} - T_{n-1}^{Data}) / (C_n - C_{n-1})$$

Where: P_n^{Data} is the data period.

T_n^{Data} is the VRefMid crossing time in either direction.

C_n is the calculated clock cycle location of T_n^{Data} .

Data Frequency Measurement

The Data Frequency measurement calculates the inverse of the data period for each cycle.

The application calculates this measurement using the following equation:

$$F_n^{Data} = 1 / P_n^{Data}$$

Where: F_n^{Data} is the data frequency.

P_n^{Data} is the data period measurement.

Data TIE Measurement

The Data TIE measurement calculates the difference in time between an edge on a sampled data waveform to the corresponding edge on a recovered data waveform with a constant frequency (zero jitter).

The application calculates this measurement using the following equation:

$$TIE_n^{Data} = T_n^{Data} - T_n'^{Data}$$

Where: TIE_n^{Data} is the data time interval error.

T_n^{Data} is the VRefMid crossing time in either direction.

$T_n'^{Data}$ is the recovered VRefMid crossing time by means of linear regression.

Data PLL TIE Measurement (TDSJIT3 v2 Advanced Only)

The Data PLL TIE measurement calculates the difference in time between the designated edge on a sampled data waveform to the designated edge on a data waveform calculated by means of a PLL. Low frequency TIE components that

are within the loop bandwidth of the PLL are tracked by the PLL and thereby removed. The application calculates this measurement using the following equation:

$$TIE_n^{Data} = T_n^{Data} - T_n'^{Data}$$

Where: TIE_n^{Data} is the data time interval error.

T_n^{Data} is the VRefMid crossing time in either direction.

$T_n'^{Data}$ is the recovered VRefMid crossing time by means of a PLL.

Cycle-to-Cycle Measurement

The Clock Cycle-to-Cycle measurement calculates the difference in period measurements from one cycle to the next.

The application calculates this measurement using the following equation:

$$\Delta P_n = P_{n+1}^{Clock} - P_n^{Clock}$$

Where: ΔP is the difference between adjacent periods.

P_n^{Clock} is the clock period measurement.

N-Cycle Measurement

The N-Cycle measurement calculates the difference in clock period measurements from cycles that are a defined number of cycles apart.

The application calculates this measurement using the following equation:

$$\Delta NP_n = (T_{n+2N}^+ - T_{n+N}^+) - (T_{n+N}^+ - T_n^+)$$

Where: ΔNP is the difference between adjacent N-cycle periods.

T_n^+ is the VRefMid crossing time in the Common Cycle Start Edge direction.

Positive and Negative Cycle-to-Cycle Duty Measurements

The Positive Cycle-to-Cycle Duty and Negative Cycle-to-Cycle Duty measurements calculate the difference in positive (or negative) pulse widths from one cycle to the next.

The application calculates these measurements using the following equations:

$$\Delta W_n^+ = W_n^+ - W_n^+$$

$$\Delta W_n^- = W_n^- - W_n^-$$

Where: ΔW^+ is the difference between positive pulse widths of adjacent clock cycles.

ΔW^- is the difference between negative pulse widths of adjacent clock cycles.

W^+ is the positive pulse width measurement.

W^- is the negative pulse width measurement.

Positive and Negative Duty Cycle Measurements

The Positive Duty Cycle and Negative Duty Cycle measurements calculate the ratio of the positive (or negative) portion of the cycle relative to the period.

The application calculates these measurements using the following equations:

$$D_n^+ = W_n^+ / P_n^{Clock}$$

$$D_n^- = W_n^- / P_n^{Clock}$$

Where: D^+ is the positive duty cycle.

D^- is the negative duty cycle.

W^+ is the positive pulse width.

W^- is the negative pulse width.

P^{Clock} is the period.

Rise Time Measurement

The Rise Time measurement is the time difference between when the VRefHi reference level is crossed and the VRefLo reference level is crossed on the rising edge of the waveform. The Rise Time algorithm uses the VRef values as the reference voltage level. Each edge is defined by the slope, voltage reference level (threshold), and hysteresis.

The application calculates this measurement using the following equation:

$$T_n^{Rise} = T_n^{Hi+} - T_n^{Lo+}$$

Where: T^{Rise} is the rise time.

T^{Hi+} is the VRefHi crossing on the rising edge.

T^{Lo+} is the VRefLo crossing on the rising edge.

Fall Time Measurement

The Fall Time measurement is the time difference between when the VRefLo reference level is crossed and the VRefHi reference level is crossed on the falling

edge of the waveform. The Fall Time algorithm uses the VRef values as the reference voltage level. Each edge is defined by the slope, voltage reference level (threshold), and hysteresis. The application calculates this measurement using the following equation:

$$T_n^{Fall} = T_n^{Lo-} - T_n^{Hi-}$$

Where: T_n^{Fall} is the fall time.

T_n^{Lo-} is the VRefLo crossing on the falling edge.

T_n^{Hi-} is the VRefHi crossing on the falling edge.

Positive and Negative Width Measurements

The Positive Width and the Negative Width measurements are the difference in time (positive or negative) between the leading edge and trailing edge of a pulse. The trailing edge is the opposite polarity (direction) of the leading edge.

The application calculates these measurements using the following equations:

$$W_n^+ = T_n^- - T_n^+$$

$$W_n^- = T_n^+ - T_n^-$$

Where: W_n^+ is the positive pulse width.

W_n^- is the negative pulse width.

T_n^- is the VRefMid crossing on the falling edge.

T_n^+ is the VRefMid crossing on the rising edge.

High Time Measurement

The High Time Measurement is the amount of time that a waveform cycle is above the VRefHi voltage reference level.

The application calculates the measurement using the following equation:

$$T_n^{High} = T_n^{Hi-} - T_n^{Hi+}$$

Where: T_n^{High} is the high time.

T_n^{Hi-} is the VRefHi crossing on the falling edge.

T_n^{Hi+} is the VRefHi crossing on the rising edge.

Low Time Measurement

The Low Time measurement is the amount of time that a waveform cycle is below the VRefLo voltage reference level.

The application calculates this measurement using the following equation:

$$T_n^{Low} = T_n^{Lo+} - T_n^{Lo-}$$

Where: T_n^{Low} is the low time.

T_n^{Lo+} is the VRefLo crossing on the rising edge.

T^{Lo-} is the VRefLo crossing on the falling edge.

Dual Waveform Measurements

The application defines conditions for a two waveforms. These algorithms use the VRef values as the reference voltage level. Each edge is defined by the slope, voltage reference level (threshold), and hysteresis.

Table 43: Dual waveform measurements

Setup
Hold
Clk-Out
Skew
Crossover Voltage (TDSJIT3 v2 Advanced only)

Setup Time Measurement

The Setup Time measurement is the elapsed time between the designated edge of a data waveform and when the clock waveform crosses its own voltage reference level. The closest data edge to the clock edge that falls within the range limits is used.

The application calculates this measurement using the following equation:

$$T_n^{Setup} = T_i^{Main} - T_n^{2nd}$$

Where: T^{Setup} is the setup time.

T^{Main} is the Main input (clock) VRefMidMain crossing time in the specified direction.

T^{2nd} is the 2nd input (data) VRefMid2nd crossing time in the specified direction.

Hold Time Measurement

The Hold Time measurement is the elapsed time between when the clock waveform crosses its own voltage reference level and the designated edge of a data waveform. The closest data edge to the clock edge that falls within the range limits is used.

The application calculates this measurement using the following equation:

$$T_n^{Hold} = T_n^{2nd} - T_i^{Main}$$

Where: T^{Hold} is the hold time.

T^{Main} is the Main input (clock) VRefMidMain crossing time in the specified direction.

T^{2nd} is the 2nd input (data) VRefMid2nd crossing time in the specified direction.

Clock-to-Output Measurement

The Clock-to-Output Time measurement is the elapsed time between when the clock waveform crosses its own voltage reference level and the designated edge of a data waveform. The closest data edge to the clock edge that falls within the range limits is used.

The application calculates this measurement using the following equation:

$$T_n^{ClkOut} = T_n^{2nd} - T_i^{Main}$$

Where: T_n^{ClkOut} is the clock-to-output time.

T_i^{Main} is the Main input (clock) VRefMidMain crossing time in the specified direction.

T_n^{2nd} is the 2nd input (data) VRefMid2nd crossing time in the specified direction.

Clock-Data-TIE Measurement

The Clock-Data-TIE measurement calculates the difference in time between an edge on a sampled data waveform to the corresponding edge on a sampled clock waveform.

The application calculates this measurement using the following equation:

$$T_n^{Clock-Data-TIE} = T_n^{2nd} - T_i^{main}$$

Where: $T_n^{Clock-Data-TIE}$ is the Clock-Data-TIE measurement.

T_n^{2nd} is the 2nd input (data) VRefMid2nd crossing time.

T_i^{main} is the Main input (clock) VRefMidMain crossing time in the specified direction delayed by specified direction delayed by specified clock delay time.

Skew Measurement

The Skew measurement calculates the difference in time between the designated edge on a principal waveform to the designated edge on another waveform. The closest data edge to the clock edge that falls within the range limits is used.

The application calculates this measurement using the following equation:

$$T_n^{Skew} = T_n^{Main} - T_n^{2nd}$$

Where: T_n^{Skew} is the timing skew.

T_n^{Main} is the Main input VRefMidMain crossing time in the specified direction.

T_n^{2nd} is the 2nd input VRefMid2nd crossing time in the specified direction.

Crossover Voltage Measurement (TDSJIT3 v2 Advanced Only)

The Crossover Voltage measurement calculates the voltage level at the crossover voltage of a differential signal pair. If there is timing jitter on one of the pair of signal lines relative to the other, the crossover point will be modulated by the jitter. Crossover times are determined from the math waveform (main-cross) for a reference level of 0 V.

The application calculates this measurement using the following equation:

$$V_n^{Crossover} = V_n^{Main} (T_n^{Crossover})$$

Where: $V^{Crossover}$ is the crossing voltage.

V^{Main} is the voltage of the Main input.

$T^{Crossover}$ is the crossover time when the two waveforms are equal in voltage.

Statistics

The application calculates statistics for all selected measurements. The application displays the following statistics in the Results menus:

- Maximum value
- Minimum value
- Mean value
- Standard deviation value
- Peak-Peak value
- Population

Maximum Value

The application calculates this statistic using the following equation:

$$Max(X) = \text{Highest Value of } X$$

Minimum Value

The application calculates this statistic using the following equation:

$$Min(X) = \text{Lowest Value of } X$$

Mean Value

The application calculates this statistic using the following equation:

$$Mean(X) = \bar{X} = \frac{1}{N} \sum_{n=1}^N X_n$$

Standard Deviation Value

It may seem odd that the equation for the estimate of the Standard Deviation contains a $1/(N-1)$ scaling factor. If you knew the true mean of X and used in place of the estimated mean \bar{X} , then you would, in fact, scale by $1/N$. But, \bar{X} is an estimate and is likely to be in error (or bias), causing the estimate of the Standard Deviation to be too small to be scaled by $1/N$. This is the reason for the

scaling shown in the equation. (Refer to Chapter 9.2 in A. Papoulis, *Probability, Random Variables, and Stochastic Processes*, McGraw Hill, 1991.)

The application calculates this statistic using the following equation:

$$StdDev(X) = \sigma_X = \sqrt{\frac{1}{(N-1)} \sum_{n=1}^N (X - \bar{X})^2}$$

Maximum Positive and Maximum Negative Difference Values

The application calculates the Max Positive Difference Value using the following equation:

$$Max(+X_{cc}) = HighestPositiveValueofX_{cc}$$

Where: $X_{CC} = X_n - X_{n-1}$

The application calculates Max Negative Difference Value using the following equation:

$$Max(-X_{cc}) = LowestNegativeValueofX_{cc}$$

Where: $X_{CC} = X_n - X_{n-1}$

The Cycle-Cycle Value below is not displayed, but is used in calculations for Max Positive and Max Negative calculations.

$$X_{CC} = X_n - X_{n-1}$$

Peak-to-Peak Value

The application calculates this statistic using the following equation:

$$PkPk(x) = Max(x) - Min(x)$$

Population Value

Population is the total number of data points applied to the displayed statistics.

$$Population(X) = N$$

Parameters

These topics describe the TDSJIT3 v2 application parameters and include the menu default settings. You should refer to the user manual for your oscilloscope for operating details of other controls, such as front-panel buttons.

The parameter tables list the selections or range of values available for each option, the incremental unit of numeric values, and the default selection or value.

Refer to the GPIB topics for a complete list of the GPIB Command Syntax. The topics include a complete list of the GPIB commands along with the arguments, variables, and variable values that correspond to the TDSJIT3 v2 parameters.

Note: Unit values shown are valid when the FINE button is enabled on the oscilloscope.

File Menus Parameters

The File drop down list includes the following options:

- Default Setup
- Dock
- Undock
- Minimize
- Exit

Note: If you create a new directory for setup files, the application remembers the path and will save files to and recall files from that directory instead of the default directory.

Table 44: File menus parameters

Option	Parameters	Default setting
Recall	<Browser>	Default directory*
Save	<Browser>	Default directory*
Recent Files	Lists up to four most recently saved or accessed setup files: 1. <setup file name> 2. <setup file name> 3. <setup file name> 4. <setup file name>	Not applicable
* Refer to the Application Directories and Usage topic for default path names.		

Control Panel Parameters

The Control Panel menu includes the following command buttons:

- Run/Stop
- Single
- New Acq
- Clear

Measurements Select

The Measurements Select menu includes the following areas:

- Select Source
- Math Defs
- Add Measurement

The Add Measurement area groups the measurements into the following categories:

- Clock: Period, Frequency, TIE, PLL TIE*, Cycle-Cycle, N-Cycle, Positive Cy-Cy Duty, Negative Cy-Cy Duty, Positive Duty, and Negative Duty
- Data: Period, Frequency, TIE, PLL TIE*
- Clk-Data: Setup, Hold, Clk-Out
- General: Rise Time, Fall Time, Positive Width, Negative Width, High Time, Low Time, Skew, and Crossover Voltage*.

Note: Both PLL TIE, and Crossover Voltage measurements are available only with TDSJIT3 Advanced.

You can set the Source option as any of the following waveforms: Ch1, Ch2, Ch3, Ch4, Ref1, Ref2, Ref3, Ref4, Math1, Math2, Math3, or Math4.

Table 45: Select Source area parameters

Measurement category	Source name	Default parameters
Clock	Clock	Ch1
Data	Data	Ch1
Clk-Data	Clock, Data	Ch1, Ch2
General	Main, Skew/Cross	Ch1, Ch2

You can select Scope User if you want to use a math waveform based on a user-defined math operation. To define your own math operation, use the oscilloscope math equation editor.

Table 46: Math Defs area parameters

Option	Parameters	Default
Math	Math1, Math2, Math3, Math4	Math1
=	Ch1-Ch3, Ch2-Ch4, Ref1-Ref2, Ref3-Ref4, Scope User	Scope User

Configure Measurements

The application shows Configure Measurement menus that apply to the selected measurement. The options available in each Configure Measurement menu are specific to the selected measurement.

Note: Data measurements do not include Waveform Edge options.

Table 47: Waveform Edges parameters

Measurement Type	Parameters	Default
Clock measurements: Clock Edge	Rise, Fall, Both	Rise
Active Edge	Rise, Fall, Both	Rise
Clock/Data measurements: Clock Edge	Rise, Fall, Both	Rise
Data Edge	Rise, Fall, Both	Both
Clock-Data-TIE measurement: Clock Edge	Rise, Fall, Both	Rise
Skew: From Edge	Rise, Fall, Both	Both
To Edge	Same as From, Opposite as From	Same as From
Crossover Voltage: Main Edge	Rise, Fall, Both	Both

Table 48: Measurement Range Limits parameters

Option	Parameters	Default
Setup, Hold, Clk-Out: Max. Value	500 ms to -500 ms in 10 ps units	10ns
Min. Value	500 ms to -500 ms in 10 ps units	0 ns
Skew: Max. Value	500 ms to -500 ms in 10 ps units	10 ns
Min. Value	500 ms to -500 ms in 10 ps units	-10 ns
Crossover Voltage: Max. Value	10 V to -10 V in 10 mV units	500 mV
Min. Value	10 V to -10 V in 10 mV units	-500 mV

Table 49: Clock-Data-TIE Measurement parameters

Option	Parameters	Default
Clock Delay Time	-1 s to 1 s in 1ps units	0 s

Table 50: N-Cycle measurement parameters

Option	Parameters	Default
Clock Edge	Rise, Fall, Both	Rise
N=		6
1 st Meas. Start @ Edge	1 to 1k in 1 units	1
Edge Increment	1 or N	1

Clock Recovery Parameters

Table 51: Clock Recovery: Reference Clock Frequency parameters

Option	Parameters	Default
Autocalc	Autocalc 1 st Acq, Autocalc Every Acq, Custom	Autocalc Every Acq
Value*	1 Hz to 5 GHz in 1 Hz units	100 Mhz
* Available when Custom is selected.		

Table 52: Clock Recovery: Loop BW parameters

Option	Parameters	Default
Loop BW: Standard Frequency (in GHz)	FC133:0.1328, FC266:0.2656, FC531:1.0625, FC1063:11.063,; FC2125:2.125, IB2500:2.5, SerATAG1:1.5, SerATAG2:3, SerATAG3:6, USB_FS:0.12, USB_HS:0.48, 1394b_S400b:0.4915, 1394b_S800b:0.983, 1394b_S1600b:1.966, GB_Ethernet:1.25, 100BaseT:0.125, OC1:0.0518, OC3:0.155, OC12:0.622, OC48:2.488	FC133:0.1328
Custom Value	1 Hz to 50 MHz in 1 Hz units	1 MHz
PLL Order	First, Second	First
Damping	0.5 to 1.0 in .01 units	0.707
* Available when the PLL Order option is set to Second.		

Advanced Clock Recovery Parameters

The Advanced Clock Recovery menu includes the following command buttons:

- OK
- Cancel

Table 53: Advanced Clock Recovery parameters

Option	Parameters	Default
Nominal Data Rate	On, Off	Off
Unit Interval*	100 ps to 1 s in 1 ps units	10 ps
Bit Rate*	1 Gb/s to 10 Gb/s	10 Gb/s
Known Data Pattern	On, Off	Off
Pattern File Name	<Browser>	Default directory**
* Available when the Nominal Data Rate option is set to On.		
** Refer to the Application Directories and Usage topic for default path names.		

Filters Parameters

Table 54: Filters parameters

Option	Parameters	Default
High Pass: Filter Spec	No filter, 1 st Order, 2 nd Order, 3 rd Order	No Filter
Freq (F1)	1 Hz to 1000 GHz in 1 KHz units*	1 KHz*
Low Pass: Filter Spec	No filter, 1 st Order, 2 nd Order, 3 rd Order	No Filter
Freq (F2)	1 Hz to 1000 GHz in 1 KHz units*	1 KHz*
* Available when the Filter Spec option is set to 1 st Order, 2 nd Order, or 3 rd Order.		

Advanced Filter Parameters

The Advanced Filter menu has an OK command button.

Note: The application displays F1 if the High Pass filter is set to On. If the High Pass filter is set to Off and the Low Pass filter is set to On, then the application displays F2.

Table 55: Advanced Filter parameter

Option	Parameters	Default
Duration	0/F1 to 10/F1 in .1 units	2/F1

TIE: RjDj Analysis Parameters (TDSJIT3 v2 Advanced Only)**Table 56: TIE: RjDj Analysis parameters (TDSJIT3 v2 Advanced only)**

Option	Parameters	Default
Separation	On, Off	Off
BER=1E-?	2 to 18 in whole number units	12
Type*	Repeating, Arbitrary	Repeating
Pattern Length*	2 UI to 1M UI in increments of 1 UI	2
Window Length***	2 UI to 16 UI in increments of 1 UI	5
Population***	5 to 5000 in units of 1	100
* Available for Data TIE or Data PLL TIE measurements.		
** Available when the Type option is set to Arbitrary.		

Configure Sources

The application includes the following Configure Source menus:

- Autoset
- Gate/Quality
- Ref Levels (Autoset or manual)
- Stat Pop Limit

The application can automatically calculate parameters for reference voltage levels based on the Ref Level Autoset Setup menu. Display the Ref Level Autoset Setup menu parameters.

The Configure Source Autoset menu includes the following command buttons:

- All
- Vertical Scale
- Horizontal Resolution

Table 57: Configure Sources Autoset parameters

Option	Parameters	Default
Optimize Horizontal For	Edge Resolution, Max Edge Count	Edge Resolution

Table 58: Configure Sources Gate/Qualify parameters

Option	Parameters	Default
Gate	Off, Zoom, Cursors	Off
Qualify with Logic Waveform		
Source	Ch1, Ch2, Ch3, Ch4, Ref1, Ref2, Ref3, Ref4, Math1, Math2, Math3, Math4	Ch4
Active	Off, High, Low	Off

The Configure Source Ref Levels menu includes the following command buttons in the Autoset area:

- Update
- Setup

Table 59: Configure Sources Ref Levels parameters

Option	Parameters	Default
Autoset	Set, Clear	Set
Source	Ch1, Ch2, Ch3, Ch4, Ref1, Ref2, Ref3, Ref4, Math1, Math2, Math3, Math4	Ch2
Rise, High	10.00 V to -10.00 V in units of 1 mV	1 V
Rise, Mid	10.00 V to -10.00 V in units of 1 mV	0 V
Rise, Low	10.00 V to -10.00 V in units of 1 mV	-1 V
Fall, High	10.00 V to -10.00 V in units of 1 mV	1 V
Fall, Mid	10.00 V to -10.00 V in units of 1 mV	0 V
Fall, Low	10.00 V to -10.00 V in units of 1 mV	-1 V
Hysteresis	0 V to 10.00 V in units of 10 mV	30 mV

* Default settings are 90% (High), 50% (Mid), 10% (Low), and 3% (Hysteresis).

Table 60: Configure Stat Pop Limit parameters

Option	Parameters	Default
Population Control	On, Off	Off
Size*	1 to 1 M in units of 1	1 k

* Available when the Population Control option is set to On.

The Configure Ref Level Autoset Setup menu includes the following command buttons:

- OK
- Cancel

Table 61: Configure Ref Level Autoset Setup Menu parameters

Option	Parameters	Default
Base-Top Method	Min-Max, Lo-High (Histogram), Auto	Auto
Rise High	0 to 100% in units of 1%	90%
Rise Mid	0 to 100% in units of 1%	50%
Rise Low	0 to 100% in units of 1%	10%
Fall High	0 to 100% in units of 1%	90%
Fall Mid	0 to 100% in units of 1%	50%
Fall Low	0 to 100% in units of 1%	10%
Hysteresis	0 to 50% in units of 1%	3%

Summaries

You can view various Measurement Summary menus that show the measurement settings. For definitions, see About Measurement Summary Menus.

Results

The application offers several types of statistics for you to view the measurement results. Some statistics are only valid for specific types of measurements. For definitions, see About Viewing Statistics.

Plots

The application includes the following Plot menus:

- Create
- Vert/Horiz Axis

The Plots Create menu includes the following command button:

- Refresh

The Histogram Vert/Horiz Axis menu includes the following command buttons:

- Autoset (recalculates the Center and Span values based on the histogram measurement statistics and then refreshes the plot)
- Refresh (refreshes the plot, usually after a manual change of the Center or Span options)

Table 62: Histogram Vert/Horiz Axis menu parameters

Option	Parameters	Default
Vertical Scale	Log, Linear	Linear
No. of bins	25, 50, 100, 250, 500	250
Center		
Positive Time	1 ps to 1 s in 1 ps units	100 ns
Pos/Neg Time	-500 ns to 500 ns in 1 ps units	0 s
Frequency	1 Hz to 10 GHz in 1 Hz units	5 GHz
Duty Cycle	0% to 100% in 5% units	50%
Pos/Neg Volts	1 V to 1 V in 1 mV units	0 V
Span		
Positive Time	1 ps to 1 s in 1 ps units	4 ns
Pos/Neg Time	1 ps to 1 s in 1 ps units	4 ns
Frequency	1 Hz to 10 GHz in 1 Hz units	5 GHz
Duty Cycle	0% to 100% in 5% units	50%
Pos/Neg Volts	0 V to 1 V in 1 mV units	10 mV

Table 63: Time Trend Vert/Horiz Axis menu parameter

Option	Parameters	Default
Mode	Vector, Bar	Vector

Table 64: Spectrum Vert/Horiz Axis menu parameters

Option	Parameters	Default
Vertical Scale	Log, Linear	Linear
Baseline*	-20 dB to 15 dB in .5 dB units	-12
Horizontal Scale	Log, Linear	Linear
Mode	Normal, Average, Peak Hold	Normal

* Available when the Vertical Scale option is set to Log.

Table 65: Bathtub Vert/Horiz Axis menu parameters

Option	Parameters	Default
Vertical Scale	Linear, Log	Log
Minimum Displayed BER=1E-?*	2 to 18 in units of 1	12
* Available when the Vertical Scale option is set to Log.		

Table 66: Transfer Function Vert/Horiz Axis menu parameters

Option	Parameters	Default
Vertical Scale	Log, Linear	Log
Horizontal Scale	Log, Linear	Log
Mode	Average, Normal	Average

Table 67: Phase Noise Vert/Horiz Axis menu parameters

Option	Parameters	Default
Vertical Position Baseline	-200 to 0 in units of 1	-170
Integrated Noise		
Lower Limit	0 Hz to 10 GHz in 1 Hz units	0 Hz
Upper Limit	0 Hz to 10 GHz in 1 Hz units	1 MHz

Logs

The application includes the following Log menus:

- Statistics
- Measurements
- Worst Case Waveforms

The Log Statistics menu includes the following command buttons:

- Yes to All
- No to All

Table 68: Log Statistics menu parameters

Option	Default
Log Statistics	
File path and name	C:\TekApplications\TDSJIT3v2\log\stats.csv
On	
Off	Off
Delete	
Save Current Statistics	
File path and name	C:\TekApplications\TDSJIT3v2\log\StatsSnapshot.csv
Save	
Delete	

The Log Measurements menu includes the following command buttons:

- Yes to All
- No to All

Table 69: Log Measurements Configure menu parameters

Option	Default
Log Measurements	
Directory path	C:\TekApplications\TDSJIT3v2\log\measurements
On	
Off	Off
Delete	
Save Current Measurements	
Directory path	C:\TekApplications\TDSJIT3v2\log\measurementsSnapshot
Save	
Delete	

The Log Worst Case menu includes the following command buttons:

- Yes to All
- No to All

Table 70: Log Worst Case Waveforms Configure menu parameters

Option	Default
Log Worst Case Waveforms	
Directory path	C:\TekApplications\TDSJIT3v2\log\waveforms
On	
Off	Off
Delete	

Utilities

The application includes the following Utility menus:

- Deskew
- Acq Timeout
- Warnings

The Deskew menu includes the following command buttons:

- Perform Deskew
- Summary

Table 71: Deskew menu parameters

Option	Parameters	Default
Reference		
Source	Ch1, Ch2, Ch3, Ch4	Ch1
Mid	-20 μ V to 20 mV in 1 μ V units	0 V
Hysteresis	1 μ V to 30 V μ in 1 μ V units	30 mV
Target		
Source	Ch1, Ch2, Ch3, Ch4	Ch2
Mid	-20 μ V to 20 mV in 1 μ V units	0 V
Hysteresis	1 μ V to 30 V μ in 1 μ V units	30 mV
Use Edges	Rise, Fall, Both	Rise
Deskew Range		
Max. Value	-24.9 ns to 25.0 ns in 1 ns units	1 ns
Min. Value	-25.0 ns to 24.9 ns in 100 ps units	-1 ns
Summary	Lists Source and resultant Deskew value	

Table 72: Acq Timeout menu parameters

Option	Parameters	Default
Acquisition Timeout	Auto, User	Auto
User: Timeout***	30 s to 24 hours in 30 s units	30 s
* Available when the Acquisition Timeout option is set to User.		
** Application waits until the Timeout value for a signal before stopping a Single or Free Run sequence with an error of failed to acquire signal.		

The Warnings menu includes the following command buttons:

- View
- Clear

Help

The Help menu includes the following items:

- Wizard
- Topics
- About TDSJIT3 v2

GPIB

You can use remote GPIB commands to communicate with the TDSJIT3 v2 application. The application includes several example files of a GPIB program. Your GPIB program should comply with the following guidelines:

The application startup must complete before sending additional GPIB commands to the application. You can query the variable *application* and it will return "TDSJIT3v2A" or "TDSJIT3v2E" when the application startup is complete.

Recall a setup file from GPIB to select measurements and set up the application. The recall must be complete before sending additional GPIB commands. You can query the variable *setup* and it will return "Ready" when the recall is complete.

The measurements cycle must complete before data is queried. You can query the variable *SequencerState* and it will return "Ready" when sequencing is complete.

The *resultFor* and *resultAcq* variables must be set before querying results and the variable changes must be complete before the results can be read. You can query the variable (*resultFor* or *resultAcq*) and it will return "Busy" until the variable has been accepted, after which it will return the value set. If *resultFor* attempts to set "measN" when there are fewer than N measurements currently configured, it will return an error string specifying the number of measurements configured.

The *error* variable should be checked to ensure that an error has not occurred. The *measError* and *rjDjError* variables return errors specific to the measurement selected by *resultFor*.

Check and service the Event Queue frequently to avoid queue overflow. This can be done using **ESR?*, followed by *allev?* if *ESR* returns non-zero. You can see an example of this logic in the function *clear_queue()*, in example program *tdsjit3ctrl.c*.

Note: GPIB variables may take up to 150 msec to be updated. Therefore, any loop which queries a GPIB variable to see when it reverts back to its initial state should wait at least 150 msec before the first query.

 **CAUTION.** Do not turn on GPIB headers in your program.

 **CAUTION.** Commands are case and space sensitive. Your program will not operate correctly if you do not follow the capitalization and spacing precisely.

Program Example

The program examples show how to communicate with the TDSJIT3 application using remote GPIB commands. The program includes the following steps:

1. Start the TDSJIT3 application.
2. Recognize an active application with GPIB protocol.
3. Recall a setup to make TDSJIT3 application selections.
4. Sequence measurements.
5. Read measurement results.
6. Exit the application.

GPIB Reference Materials

To use GPIB commands with your oscilloscope, you can refer to the following materials:

- The GPIB Program Example topic for guidelines to use while designing a GPIB program
- The Parameters topics for range of values, minimum units and default values of parameters
- The programmer information in the online help of your oscilloscope

Starting and Setting Up the Application Using GPIB

To start the TDSJIT3 application, you must send the oscilloscope the following GPIB command:

```
application:activate "Jitter Analysis - Advanced"
```

To start the TDSJIT3E application, you must send the oscilloscope the following GPIB command:

```
application:activate "Jitter Analysis - Essentials"
```

Note: The name of the application in the previous string is identical to the name of the application from the oscilloscope Run Application list.

The application uses the GPIB VARIABLE:VALUE command with arguments to execute some features. The set of GPIB commands does not include the variable names and variable values necessary to select and configure the measurements in the GPIB program.

You must manually set up the application and oscilloscope, selecting and configuring the measurements that you want to use with your GPIB program, and save them in a setup file in the default setup folder for that module. To save a setup file, refer to Saving a Setup File. Use the name of the saved setup file as the value for the "recallName" variable in your GPIB program.

Variable:Value Command

The VARIABLE:VALUE TDS command accepts string arguments for a control or data variable and a value to which to set the argument.

Syntax

To set a variable to a value:

```
VARIABLE:VALUE "<variable name>","<variable value>"
```

Note: The arguments <variable name> and <variable value> are required in the order indicated.

To query the value in a variable:

```
VARIABLE:VALUE? <variable name>
```

 **CAUTION.** Commands are case and space sensitive. Your program will not operate correctly if you do not follow the capitalization and spacing precisely.

Table 73: Variable: Value command arguments and queries part 1

Group/name	Value	Function	Query form returns ...
application	{exit}	Terminates the active application	TDSJIT3v2A or TDSJIT3v2E
Sequencer			
sequencerMode	{MeasureOnly, FreeRun, Single}	Sets the sequencer mode; startup default is Single.	Sequencer mode
sequencerState	{Stop, Sequencing}	Sends the Measurement Sequencing or the Stop Sequencing command	{Most recent setting, Ready}; <i>Ready</i> indicates that the value was processed
reset	{Results}	Clears the active measurement results and plots	{Most recent setting, Ready}; <i>Ready</i> indicates that the value was processed
Save/Recall			
setup*	{Default, Recall}	Performs the Save/Recall/Default setup action	{Most recent setting, Ready} <i>Most recent setting</i> if value (action) is being processed; <i>Ready</i> indicates value has been processed
recallName†	<filespec>‡ filename without extension	Sets the Recall setup file name; filename extension .ini is optional and startup default is setup.ini	Current <filespec>‡ filename without extension
recallDirectory	<i>Query only</i>	Reports the location of the Recall directory displayed in the File>Recall... list; startup default is \\TekApplications\TDSJIT3\setup	Current <pathspec>§ directory value
Source Scaling			
sourceScaleAutoset	{Vert, Horiz, All}	Starts autoset sequence using the preference in sourceScaleOptimize	{Most recent setting, Ready}; <i>Ready</i> indicates value has been processed
sourceScaleOptimize	{Count, Resolution}	Selects Horizontal Autoset preference: High Edge Count or better Edge Resolution (default)	Current value
* Query may return an error code if command fails.			
† If the file name is not valid (contains characters other than letters, digits, and dots), then the application resets to the last set valid file name. Query to these commands return the file name without extension.			
‡ <filespec> is a string of from 1 to 40 characters that are valid in the Windows file system standards.			
§ <pathspec> is a Path string of from 1 to 40 characters that are valid for pathnames according to Windows file system standards. In Query mode, the middle characters of strings longer than 40 characters will be replaced with "..." to bring the string length to 40.			

Table 74: Variable: Value command arguments and queries part 2

Group/name	Value	Function	Query form returns ...
Source ref levels			
refLevelSelect	{C1, C2, C3, C4, R1, R2, R3, R4, M1, M2, M3, M4}	Selects the source for refLevel to Autoset	Current value
refLevelAutoset	{Selected, All}	Starts autoset sequence; <i>Selected</i> autosets source specified by refLevelSelect and <i>All</i> operates on all active sources	{Most recent setting, Ready}; Ready indicates that the value was processed
Logging Results			
logCurrentStats†	{Now}	Saves current acquisition and all acquisition statistics to the Save Current Statistics log file	Returns <i>{Most recent setting, Ready}</i> <i>Ready</i> indicates value has been processed
logCurrentStatsDestination‡	<filespec>§ filename without extension	Sets the Save Current Statistics file name, displayed in the Log> Statistics menu; filename extension .csv is optional; startup default is statsSnapshot.csv	Current <filespec>§ file name without extension
logCurrentStatsDirectory	Query only	Reports the location of Save Current Statistics directory, displayed in the Log> Statistics menu; startup default is \TekApplications\TDSJIT3\log	Current <pathspec># directory value
logStatsDestination‡	<filespec>§ filename without extension	Sets the Log Statistics file name, displayed in the Log> Statistics menu; filename extension .csv is optional; startup default is stats.csv	Current <filespec>§ file name without extension
† Query may return an error code if command fails.			
‡ If the file name is not valid (contains characters other than letters, digits, and dots), then the application resets to the last set valid file name. Query to these commands return the file name without extension.			
§ <filespec> is a string of from 1 to 40 characters that are valid in the Microsoft Windows file system standards.			
# <pathspec> is a Path string of from 1 to 40 characters that are valid for pathnames according to Windows file system standards. In Query mode, the middle characters of strings longer than 40 characters will be replaced with “...” to bring the string length to 40.			

Table 75: Variable:Value command arguments and queries part 3

Group/name	Value	Function	Query form returns ...
Logging Results			
logStatsDirectory	Query only	Reports the location of Log Statistics directory, displayed in the Log> Statistics menu; startup default is \TekApplications\TDSJIT3\ log	Current <pathspec>* directory value
logStatsState	{On, Off}	Sets the state of Log Statistics ; when On, the Log Statistics file is amended with statistics from the current acquisition and all acquisitions after each sequence	Current value
logCurrentMeasurements†	{Now}	Saves Current Measurements into associated Log> Measurements> File Names	{ <i>Most recent setting, Ready</i> } Ready indicates value has been processed.
logCurrentMeasurementsDirectory	Query only	Reports the location of Save Current Measurements directory, displayed in the Log> Measurements> Config menu; startup default is \TekApplications\TDSJIT3\ measurementsSnapshot	Current <pathspec>† directory value
logMeasurementsDirectory	Query only	Reports the location of Log Measurements directory, displayed in the Log> Measurements> Config menu; startup default is \TekApplications\TDSJIT3\ measurements	Current <pathspec>† directory value
logMeasurementsState	{On, Off}	Sets the state of Log Measurements : when On, the measurements from the current acquisition are saved into associated Log> Measurements>File Names	Current value
* <pathspec> is a Path string of from 1 to 40 characters that are valid for pathnames according to Windows file system standards. In Query mode, the middle characters of strings longer than 40 characters will be replaced with “...” to bring the string length to 40.			
† Query may return an error code if command fails.			

Table 76: Variable:Value command arguments and queries part 4

Group/name	Value	Function	Query form returns ...
Logging Results			
logWorstcaseDirectory	Query only	Reports the location of Log Worst Case Waveforms directory, which is displayed in the GUI's Log> Worst Case Waveforms>Config Panel; startup default is \\TekApplications\TDSJIT3\ waveforms	Current <pathspec>* directory value
logWorstcaseState	{On, Off}	Sets the state of Log Worst Case Waveforms : when On, the worst case waveforms are saved (when they occur) into associated Log> Measurements>File Names	Current value
Result variables			
resultFor	{Meas1, Meas2, Meas3, Meas4, Meas5, Meas6}	Specifies the measurement number for which results are requested by location in the results table; you can query the "measurement" variable to get a keycode for the name of the measurement and input source	After set to a Meas <i>n</i> value, query returns "Busy" until results are refreshed, then value set back to entered value Meas <i>n</i> ; see the About the GPIB Program and Guidelines topic
resultAcq	{Current, All}	Specifies the measurement result group as the most recent acquired (Current) or as an accumulation of all the measurements (All)	After set to Current or All, query returns "Busy" until results are refreshed, then value set back to entered value
TIE RjDj/BER (Applies to the measurement selected by the resultFor command)			
rjDjBER	{On, Off}	Forces the RjDj BER results to be updated.	After set to "On," query returns "Busy" until RjDj results are refreshed, then set back to "On"
rjDjBERTarget	{range: 2...18, by 1}	Sets the exponent component of the BER (i.e., 10 [?])	After set to a new value query returns "Busy" until RjDj results are refreshed then set back to the new value
* <pathspec> is a Path string of from 1 to 40 characters that are valid for pathnames according to Windows file system standards. In <i>Query</i> mode, the middle characters of strings longer than 40 characters will be replaced with "..." to bring the string length to 40.			

Table 77: Variable:Value command arguments and queries part 5

Group/name	Value	Function	Query form returns ...
Plot Export			
plotSelect	{range: 1..4}	Sets the plot window to which a subsequent plot export command applies	Current value
plotSpec	Query only	Reports the plot type, measurement, and source(s) for the plot defined by plotSelect	"key#,source(s),type"*, for example "Cycle TrendJavaplot1CP1R1"
plotExport	{Data, Image, Ref}	Saves the plot as defined by plotSelect in the specified format	{Ready, Plot Export Error} <u>Ready</u> indicates value has been processed, otherwise, check the "error" variable for the error.
plotImageDir	<pathspec>†	Sets the directory to which a plot image will be saved.	Current <pathspec>† directory value
plotImageDest	<filespec>‡, where the extension must be {png, jpg, bmp}	Sets the filename under which a plot image will be saved; default file name is aPlotImage.png. If file extension is not supplied, then file will be a .png	Current <filespec>‡ file name with extension
plotDataDir	<pathspec>†	Sets the directory to which plot data will be saved	Current <pathspec>† directory value
plotDataDest	<filespec>‡, where the extension must be {txt, csv, mat}	Sets the filename under which plot data will be saved; default file name is aPlotData.txt. If file extension is not supplied, then file will .txt.	Current <filespec>‡ file name with extension
plotRefDest	{Ref1, Ref2, Ref3, Ref4}	Sets the scope reference channel to which a subsequent plot waveform export command applies	Current value
<p>* key is an abbreviation for the selected measurement shown in the Measurement Names and Key topic. # is an integer that distinguishes between multiple measurements of the same type. source(s) is an abbreviation for the source or sources associated with the measurement shown in the Source Names and Key topic. type is an abbreviation for the plot format shown in the Plot Names and Key topic. For example, "CP1,Ch4,HS" identifies a Histogram plot of the first Clock Period measurement on Channel4, and "SU2,Ch3,M1,TT" identifies a Time Trend plot of the second Setup measurement from Channel3 to Math1.</p>			
<p>† <pathspec> is a Path string of from 1 to 40 characters that are valid for pathnames according to Windows file system standards. In <i>Query</i> mode, the middle characters of strings longer than 40 characters will be replaced with "..." to bring the string length to 40.</p>			
<p>‡ <filespec> is a string of from 1 to 40 characters that are valid for filename strings according to Windows file system standards.</p>			

Measurements Results Queries

 **CAUTION:** After sending the resultFor and the resultAcq commands, be sure to wait until the command has been accepted prior to doing measurement queries. To do this, wait at least 150 milliseconds and then query the value of resultFor or resultAcq again. The variable will return Busy until it is accepted, after which it will return the value that you sent. If you send a resultFor value that is invalid, the value returned following the Busy will be an error string.

You need to use the VARIABLE:VALUE? form to enter measurement results queries in your GPIB program. Before you can do this, you must first set the measurement with the resultFor command. You can select the Current or all acquisition statistics with the resultAcq command.

The *Variable: Value JITTER3 Command Arguments and Queries* tables list the measurement results queries for the measurement selected in the resultFor and the resultAcq variables:

Table 78: Measurement results queries

Variable name	Return value for measurement specified by resultFor and resultAcq
measurement	"key,source(s)" pair. The key as an abbreviation for the selected measurement (e.g., "CP" for Clock Period) followed by an integer; see the Measurement Names and Key topic for a complete list of measurement abbreviations Source(s) is an abbreviation for the source or sources associated with the measurement (e.g., "Ch1" for Channel 1 or "Ch1Ch2" for a measurement that requires both Channel 1 and Channel 2; see the Source Names and Key topic
Statistical Results	<i>Basic statistics applicable for all measurements</i>
measUnits	Units string for the measurement (e.g., "s" for seconds for Period)
max	Maximum measurement value
maxPosDev	Magnitude of the largest positive change of the measurement
maxNegDev	Magnitude of the largest negative change of the measurement
mean	Mean value of the result
min	Minimum measurement value
pkpk	Peak-to-peak measurement value (max – min)
population	Population (number of) measurements used to calculate the current statistics
stdDev	Standard deviation measurement set
RjDj Results	<i>Applies for TIE type measurements only. For non-TIE measurements, an empty string is returned. For TIE measurements with RjDj turned off, a null string is returned</i>
dataDependent	Data dependent jitter component of the TIE Jitter
dutyCycle	Duty cycle jitter component of the TIE Jitter
deterministic	Deterministic jitter component of the TIE Jitter
periodic	Periodic jitter component of the TIE Jitter
random	Estimated random jitter component of the TIE Jitter
totalJitter	Estimated total jitter component at the designated BER of the TIE Jitter
eyeOpening	estimated eye opening at the designated BER of the TIE Jitter
equivDeterministic	Equivalent deterministic jitter component of the TIE Jitter
equivRandom	Equivalent estimated random jitter component of the TIE Jitter
equivTotalJitter	Equivalent estimated total jitter component at the designated BER of the TIE Jitter
Messages	<i>String that returns if the TDSJIT3 application has problems; refer to the GPIB Commands Error Codes topic</i>
error	General error
measError*	Measurement specific error
rjDjError*	RjDj analysis related error
warning	Warning, if any, from the most recent measurement
* Returns an error string in the form of "1:* , 2:* , 3:* , 4:* , 5:* , 6:* " where the * will be "None" or an error number, such as E801. For example, "1 :*" represents the first measurement in the active measurements table. For non-active measurements and for active measurements without error status, the application returns "None." Otherwise, the application returns the error number as listed in the GPIB Error Codes topic.	

Table 79: Measurement names and key

Measurement	Key	Measurement	Key
Clock		Clock-Data	
Period	CP	Setup	SU
Frequency	CF	Hold	HOLD
TIE	TIE	Clock-Out	TCO
PLL TIE	CPLL	Clock-Data-TIE	CDJ
Cycle-Cycle	CCP	General	
N-Cycle	NCP	Positive Width	PW
Positive Cy-Cy Duty	PCCD	Negative Width	NW
Negative Cy-Cy Duty	NCCD	Rise Time	RISE
Positive Duty Cycle	PDC	Fall Time	FALL
Negative Duty Cycle	NDC	High Time	HIGH
Data		Low Time	LOW
Period	DP	Skew	SKEW
Frequency	DF	Crossover Voltage	CRVT
TIE	DTIE		
PLL TIE	DPLL		

Table 80: Source names and key

Source	Key	Source	Key	Source	Key
Channel1	Ch1	Ref1	R1	Math1	M1
Channel2	Ch2	Ref2	R2	Math2	M2
Channel3	Ch3	Ref3	R3	Math3	M3
Channel4	Ch4	Ref4	R4	Math4	M4

Table 81: Plot names and key

Plot type	Key	Plot type	Key
Histogram	HS	Bathtub	BT
Time Trend	TT	Transfer Function	TF
Cycle Trend	CT	Phase Noise	PN
Spectrum	SP		

Table 82: Error codes

Code	Description
E014	Unable to import waveform; stopping sequencing
E101	Failed to acquire signal; timed out waiting for trigger
E102	Unable to acquire waveform; sequencing halted
E103	Record length changed during sequencing
E104	Not enough edges in qualified portion of waveform
E105	Unable to turn on sources
E106	Not enough edges for Deskew to work
E107	Deskew only works on live channels
E108	No measurements selected
E109	GPIB timeout occurred
E110	GPIB error occurred
E151	Level Too High for <Vref ID> -- Autoset Ref Level
E152	Level Too Low for <Vref ID>
E153	Hysteresis Too Wide for the signal for <Vref ID>
E154	Signal never above Vref Mid + hysteresis / 2 for <Vref ID>
E155	Signal never below Vref Mid - hysteresis / 2 for <Vref ID>
E201	The number of edges is not sufficient for a measurement
E202	Upper range should be greater than lower range
E203	Unable to estimate baud rate; check configuration
E204	PLL bandwidth is too high; maximum is baud rate / 10
E221	Unable to read pattern file
E222	Pattern file has too few bits
E223	Pattern file has too many bits
E301	Conflict detected in resource usage
E401	No signal to work on; check for a valid signal
E402	No source selected
E403	No active sources
E404	Error setting reference levels
W405	Source amplitude is extremely low
E406	Autoset failed
E407	Vertical autoset failed
E408	Horizontal autoset failed
W409	Waveform is clipped

Code	Description
E501	Low signal amplitude
E502	Low resolution; horizontal scale too high
E503	Uncertain edge
E504	Clipping positive/negative
E505	Clipping positive
E506	Clipping negative
E507	No signal to work on
E508	No valid edge - no arm sample
E543	Measurement Warning: Low resolution
W701	Turning logging and Sequencing Off. Check if: 1. Disk is available. 2. Disk has free space
E702	Unable to read from data file
E703	Unable to write to data file. Disk might be full
E704	Unable to delete data file
E705	Turning logging and Sequencing Off. Check if: 1. Directory is available. 2. Log file is open
E706	Turning logging and Sequencing Off. Unknown Error occurred in Measurement Logging. Turning logging Off
E707	Unable to write log file to disk. Check if: 1. Disk is available. 2. Disk has free space
E708	Unable to write log file to disk. Check if: 1. Directory is available. 2. Log file is Open/ReadOnly
E801	No Clock TIE Data to do RjDj separation
E802	Not enough clock edges for RjDj separation. Need minimum 500 Edges
E803	No Data TIE data to do RjDj separation
E804	Not enough data edges for RjDj separation. At least 50 pattern repeats are required
W805	Marginal data repeats for RjDj separation. 100 pattern repeats are required for high confidence
E806	Pattern Length Error
W807	Warning: For RjDj analysis on both edges of a clock signal, the pattern length should be set to 2 (but isn't)
W808	Warning: For RjDj analysis on only one polarity of clock of clock signal, the pattern length should be set to 2 (but isn't)
W809	Pattern Length Warning
E810	Not enough good bits to perform Rj and Dj separation
E811	Effective RjDj separation stops proceeding since eye is closed at BER = 1E-9 level

Code	Description
E901	There are currently no results to snapshot. Please perform a measurement first
E903	Select at least one measurement from the table before choosing Save
W904	Statistics logging turned off. Statistics for ≥ 1000000 acquisitions logged to file
W905	Measurement logging turned off. ≥ 1000000 measurements logged to file(s).
W1001	Maximum population limit reached:
W1111	Jitter Transfer Plot requires two measurements
W1112	No measurements are enabled, unable to create plot
E1113	Error exporting plot data
E1114	Error exporting plot image
E1115	Error exporting plot to Ref wfm
E1116	Error creating directory
E1201	Filter cut-off frequency is higher than Nyquist frequency. Filter settings ignored
E1202	Result has 0 population since transient duration of filter is set longer than waveform time span. Either acquire a longer duration waveform, increase your filter bandwidth, or reduce the filter settling time
W1203	Settling time of filter is small relative to $1/\text{bandwidth}$. Initial transient may not be completely removed from measurement results
W1301	Clock recovery from data pattern disagrees with nominal data rate. Clock recovery from data pattern is used
W1302	Clock recovery result implies unstable data rate. Check nominal data rate and other configurations
W1303	Clock recovery result implies unstable data rate. Check configurations

Index

.BMP File.....	xix, 8	Method Used to Perform Measurements	111
Feedback Item.....	xix	Minimizing and Maximizing	6
.CSV File	8, 72	Navigating.....	10
Saving Statistics.....	72	Returning to Oscilloscope.....	6
.INI File.....	8	See Also Application Examples.....	101
Feedback Item.....	xix	See Also Tutorial	82
.JPG File	8	Setting Up for Analysis.....	15
.MAT File	8	Setup Overview	11
.PNG File	8	Starting from an Oscilloscope.....	5
.SET File	8	Starting with GPIB.....	140
Feedback Item.....	xix	User Interface.....	14
.TXT File	8	Application Example 1.....	102, 103, 104, 105, 106
.WFM File.....	8	Calculating the Pattern Length	103
Feedback Item.....	xix	Measuring Rj/Dj and Tj @ BER.....	104
> Delimiter Symbol	xvii	Spectral Analysis Used to Find Jitter Source..	105
5-Time Free Trial.....	xv	View of Spurs	106
Access to PDF Files.....	xvii	Application Example 2.....	107, 108
Accessories	2	Trend Analysis Used to Find Jitter Amplitude	
Acquiring Data.....	50	and Anomalies.....	108
Acquisition Timeout	79, 138	Arbitrary Patterns.....	26, 113
Parameters	138	Analysis Based Rj/Dj Separation Algorithm ..	113
Utility Menu	79	Rj/Dj Analysis	26
Active Edge Options	21	Area Definition	13
Advanced Clock Recovery	32, 33, 130	Autoset Reference Voltage Levels.....	43
Options	33	Autoset Sources.....	38
Parameters	130	See Configure Sources Autoset	38
Setup.....	32	Back Button	xviii
Advanced Filters.....	36, 130	Band Pass Filter	34
Configuration.....	36	Bandwidth Extension in use While Deskewing.....	3
Options	36	Basic Operations	5
Parameters	130	Bathtub Curve and BER Versus Decision Time....	26
Application.....	xv, 6, 10, 11	Bathtub Plot	54
CD Contents	xvi	Definition	54
Directory Structure and Usage.....	7	Parameters.....	135
Exiting	7	Usage	56
File Name Extensions.....	8	BER and Tj Estimation Algorithm.....	114
GPIB Commands.....	139	BER Versus Decision Time and Bathtub Curve....	26
Installing Procedures in Installation Manual	2	Box Definition	13

Browse Definition.....	13	Advanced Setup.....	32
Button Definition.....	13	Constant.....	28
Categories of Online Help Information.....	xvii	Constant Setup.....	29
CD contents.....	xvi	Phase-Locked Loop PLL.....	30
Check Box Definition.....	13	PLL Area.....	31
Clear Results Command Button.....	51	PLL Loop Bandwidth Options.....	31
Clearing.....	19, 52, 66	PLL Setup.....	30
Measurements.....	19	Reference Clock Frequency Area.....	30
Plots.....	66	Reference Clock Frequency Options.....	29
Results.....	52	Straight Line.....	28
Clock Edge Options.....	21, 22	Configure Filters.....	33, 34, 35, 36, 130
Clock Frequency Measurement.....	115	Advanced Area.....	36
Algorithm.....	115	Advanced Parameters.....	130
Clock Period Measurement.....	115	Band Pass.....	34
Algorithm.....	115	Characteristics.....	33
Clock PLL TIE Measurement.....	116	Menu.....	35
Algorithm.....	116	Options.....	35
Clock Recovery.....	28, 30, 129, 130	Parameters.....	130
Advanced Options.....	33	Configure Gating.....	38, 132
Advanced Parameters.....	130	Localizing Measurements.....	50
Configuration.....	28	Menu.....	41
Constant.....	28	Options.....	41
Loop BW Parameters.....	129	Parameters.....	132
Phased-Locked Loop PLL.....	30	Configure Measurement Menus.....	19, 20, 85, 91
Reference Clock Frequency Parameters.....	129	Available by Measurement.....	20
Clock Recovery Setup.....	29, 30	Clock-to-Output Example.....	91
PLL.....	30, 31	Definitions.....	19
Clock TIE Measurement.....	116	Period Example.....	85
Algorithm.....	116	Configure Menus.....	19, 37, 58, 72
Clock-Data-TIE measurement.....	122	Log.....	72
Algorithm.....	122	Measurements.....	19
Clock-Data-TIE Measurement Configuration.....	25	Plots.....	58
Clock-to-Output Measurement.....	122	Configure Qualify.....	38, 41, 132
Algorithm.....	122	Options.....	41
Command Button Definition.....	13	Parameters.....	132
Compatibility.....	2, 78	Configure Ref Levels.....	38, 49, 132
Setup Files From Prior Version of Software.....	78	Basic Information.....	42
Configure Clock Recovery.....	28, 29, 30, 31, 32, 33	Entering Values.....	9
Advanced Area.....	33	Manually.....	46
Advanced Options.....	33	Menu.....	48

Options	47	Horizontal	69
Parameters	132	Min/Max	70
See Also Reference Voltage Levels	42	Sync	69
Summary	49	Vertical	68, 69
Configure Ref Levels Autoselect	43, 49, 86, 91	Cycle Trend Plot	54, 56
Basic Information	43	Definition	54
Before Update Example	86	Usage	56
Menu	46	Cycle-to-Cycle Measurement	118
Parameters	133	Algorithm	118
See Also Reference Voltage Levels	43	Data Edge Options	22
Summary	49	Data Frequency Measurement	117
Updated Example	86, 91	Algorithm	117
Configure Sources Autoselect	40, 131	Data Period Measurement	117
Menu	40	Algorithm	117
Parameters	131	Data PLL TIE Measurement	117
Configure Stat Pop Limit	38, 132	Algorithm	117
Menu	49	Data Points Logged as a Snapshot	95
Options	48	Data TIE Measurement	117
Parameters	132	Algorithm	117
Configure TIE RjDj	27, 28	Default Setup File	78
Data Pattern Areas	28	Delimiter Symbol >	xvii
Options	27	Denominator Option	61
Separation	28	Deskew	3, 4, 137
Total Jitter	28	Example	4
Connecting to a DUT	2	Oscilloscopes with Bandwidth Extension	3
Constant Clock Recovery	28, 29	Parameters	137
Setup	29	Probes and Channels	3
Control Panel	50, 52	Steps	4
Definition	13	Deskew Summary Example	4
Functions	51	Device Under Test and Connections	2
Parameters	127	Differences Between the TDSJIT3 v2 Advanced and TDSJIT3 v2 Essentials	1
Usage	50	Directory Structure for TDSJIT3	8
Create Plots of Results	88	Docking the Application Window	79
Crossover Voltage Measurement	18, 123	Documentation	xv
Algorithm	123	DUT Definition	xvii
Cursors	40, 103	Edges Gating	40
Gating Definition	41	Edit Box	9
Use to Calculate Pattern Length	103	Effective Rj and Tj Estimation Algorithm	114
Cursors in a Plot	67, 68, 69, 70	Equivalent Rj/Dj Results	53
Focusing	68	Error Codes	150, 151

Exiting the Application	7	Gated Measurements	40
Exporting Plot Information	70, 71, 72	See Configure Gating	40
Images	71	Gating Off Definition	41
Raw Plot Data	70	General Safety Summary	xiii
Reference Waveform	72	GPIB	139, 149, 151
Extensions	8	Commands Error Codes	150
Fall Time Measurement	18	Commands Error Codes	151
Algorithm	120	Key for Measurement Names	149
Falling Versus Rising Thresholds	42	Key for Plot Names	149
FAX	xix	Key for Source Names	149
Feedback	xix	Oscilloscope Commands	xv
FFT of a Time Trend Plot	56	Reference Materials	140
File Menus	10	Reference Materials	xv
Definitions	10	Starting an Application	140
Parameters	126	Help Menu	138
Recall Browser	77	Parameters	138
Save Setup Browser	76	Help Topics	xviii
See Also Recalling Setup Files	10	High Reference Voltage Levels	42
See Also Saving Setup Files	10	High Time Measurement	18, 120
File Names	8, 74, 75	Algorithm	120
Extensions	8	Histogram Plot	54
Log Measurements	74	Definition	54
Filters	34, 35, 36, 37, 130	Parameters	133
Advanced	36	Usage	55
Advanced Parameters	130	Hold Time Measurement	121
Band Pass	34	Algorithm	121
Characteristics	33	Horizontal Autoset of the Sources	38
Options	35	Horizontal Cursors in a Plot	69
Parameters	130	Hyperlink	xviii
Smoothing Window	37	Hysteresis	42, 43
Find Tab in Online Help and Searches	xviii	Influence of High Pass Filters on Period and Frequency Statistics	35
FINE Button	9	Input Directory Name Dialog	96
Optimum Parameter Values	126	Installation Procedures	
Focusing Cursors in a Plot	68	See Installation Manual	2
Free Run	50, 51	Invert Option	61
Mode	50	Jitter Amplitude and Anomalies	108
Free Trial	xv	Finding with Trend Analysis	108
Frequency Measurement	115, 117	Jitter Primer	xvi
Algorithm	115, 117	Jitter Source	105
From and To Edge Options	22		

Finding with Spectral Analysis.....	105	Parameters.....	129
Jitter Wizard.....	11, 12	Low Reference Voltage Levels.....	42
Launched.....	12	Low Time Measurement.....	18, 120
Keyboard.....	2	Algorithm.....	120
Keypad.....	9	Main Edge Option.....	23
Definition.....	13	Math Defs Area.....	18, 127
Icon.....	9	Parameters.....	127
Using.....	9	Math Waveforms.....	18
Limits for Population.....	48	Maximizing the Application.....	6
See Configure Stat Pop Limit.....	48	Maximum Negative Difference Value Algorithm.....	124
List Box Definition.....	13	Maximum Positive Difference Value Algorithm.....	124
Localizing Measurements.....	50	Maximum Value Algorithm.....	123
Log Measurements.....	73, 74, 95, 96, 97, 136	Mean Value Algorithm.....	123
Data Points as a Snapshot.....	95	Measurement Names and Key for GPIB.....	149
Dialog to Save.....	96	Measurement Range Limits.....	128
File Names.....	74	Options.....	23
Menu.....	95	Parameters.....	128
Options.....	74	Measurements.....	11, 18, 19, 20, 49, 50, 51, 52, 54
Parameters.....	136	Acquiring Data.....	50
Path to Files.....	97	Algorithms.....	111
Tutorial.....	95	Available Configuration Menus.....	20
Viewing.....	97	Clearing.....	19
Log Statistics.....	72, 73, 92, 93, 94, 135	Configure Menu.....	19
Dialog to Save.....	93	Configure Menu Definitions.....	19
Menu.....	93	Definitions.....	18
Options.....	73	Jitter Wizard.....	11
Parameters.....	135	Plot Types.....	54
Path to File.....	94	Population Limits.....	48
Tutorial.....	92	Results.....	52
Viewing.....	94	Results Queries for GPIB.....	147
Log Worst Case Waveforms.....	74, 75, 97, 98, 99	Select Menu Parameters.....	127
Dialog to Save.....	99	Selecting.....	15
File Names.....	75	Measurements Summary.....	49, 92
Menu.....	98	Example.....	92
Options.....	75	Menu Definitions.....	49
Parameters.....	136	Measuring Rj/Dj and Tj @ BER.....	104
Path to Files.....	99	Menu Bar Definition.....	13
Tutorial.....	97	Menu Definition.....	13
Loop BW.....	129	Menu Map in the Reference Guide.....	xv
Options.....	31	Menus..	10, 12, 21, 22, 23, 24, 28, 30, 31, 33, 35, 36, 40, 49, 64, 79, 80, 92, 93, 95, 98

Acquisition Timeout Utility.....	79	Algorithm.....	120
Configure Clock Recovery	30, 31, 33	New Acquisition Button.....	51
Configure Filters.....	35, 36	Noise on Waveforms.....	43
Configure Gate/Qualify	41	Numerator Option	61
Configure General	21, 22, 23, 24	Numerical Entries	9
Configure Ref Levels.....	48	Online Help.....	xvii, xviii, xix
Configure Ref Levels Autoset	46	Groups of Topics	xvii
Configure Sources Autoset.....	40	Searches and Find Tab.....	xviii
Configure Stat Pop Limit.....	49	Operating Basics	5
Files	10	Option Definition	13
Jitter Wizard	12	Oscilloscope.....	3, 10, 49
Log Measurements	95	Bandwidth Extension.....	3
Log Statistics	93	Compatibility	2
Log Worst Case Waveforms.....	98	FINE Button.....	9
Plot Create	58	Horizontal Scale.....	49, 50
Plot Windows	64	Localizing Measurements	50
Summaries	49, 92	Menu Bar	6
Warnings Utility	80	Power	2
Microsoft Paint	xix	Record Length	50
Mid Reference Voltage Levels	42	Reference Memory Setup Menu	83
Min/Max Button	70	Setting Up for the Tutorial.....	82
Minimizing the Application.....	6	Setup Guidelines	111
Minimum Value Algorithm	123	Trigger Level and Slope	50
Mini-Tutorial in the Reference Guide.....	xv	Parameters.....	126
Miscellaneous Summary	49	Pattern Length Measured with Cursors.....	103
Moving and Resizing a Plot.....	65	Patterns.....	25
Multipurpose Knob	13	Arbitrary	26
Definition.....	13	Repeating and Using a Spectral Approach	25
Icon	9	PDF Files	xvi, xvii
Using.....	9	Accessing.....	xvii
Navigating the Application.....	10	On the Applications CD.....	xvi
N-Cycle Measurement	24, 118, 129	Peak-to-Peak Value Algorithm	124
Algorithm.....	118	Period Measurement	115, 117
Options	24	Algorithm.....	115, 117
Parameters	129	Phase Noise Plot.....	54, 57, 135
Negative Cy-Cy Duty Measurement.....	118	Definition	54
Algorithm.....	118	Parameters.....	135
Negative Duty Cycle Measurement	119	Usage	57
Algorithm.....	119	Phase-Locked Loop Clock Recovery.....	30
Negative Width Measurement	18, 120	PLL Clock Recovery.....	30

Setup	30	Probes	2
PLL Loop Bandwidth	31, 129	Connecting to a DUT	2
Options	31	Deskewing	3
Parameters	129	Product Description	xv
PLL TIE Measurement	116, 117	Program Example	140
Algorithm	116, 117	Programmer Information	140
Plot Create	57	Qualify Measurements	40
Plot Names and Key for GPIB	149	Range Limits Options	23
Plot Usage	56, 57	Recall Recent Drop Down list Example	78
Bathtub	56	Recalling	77, 78
Cycle Trend	56	Default Setup File	78
Histogram	55, 56	Recently Saved or Accessed Setup File	78
Phase Noise	57	Saved Setup File	77
Time Trend	56	Setup File Browser	77
Transfer Function	57	Setup File From Prior Version of Software	78
Plots Configure	58, 135	Waveform File to Reference Memory	83
Parameters	133, 134, 135	Record Length	111
Plots Create	54	See Oscilloscope	111
Definitions	54	Ref Levels Autoset	43
Options	58	See Configure Ref Levels Autoset	43
Plotting Results	54, 64, 65, 66	Ref Levels Menu	42
Creating	57	See Configure Ref Levels	42
Deleting	66	Ref Levels Summary Example	92
Functions	64	Reference Clock Frequency	129
Moving and Resizing	65	Options	29
Overview	54	Parameters	129
See Exporting Plot Information	70	Reference Voltage Levels	42, 44, 47, 49
Selecting and Viewing	65	Adjusting Manually	46
Toolbars	64	Autoset and Choosing Voltages	44
Using Cursors	67	Autoset and When It Occurs	44
Population	124	Autoset Versus Manual	43
See Configure Stat Pop Limit	48	Basic Information	42
Value Algorithm	124	Diagram	42
Positive Cy-Cy Duty Measurement	118	Hysteresis	43
Algorithm	118	Options	47
Positive Duty Cycle Measurement	119	Rising Versus Falling Thresholds	42
Algorithm	119	See Also Configure Ref Levels	42
Positive Width Measurement	18, 120	See Also Configure Ref Levels Autoset	43
Algorithm	120	Summary	49
Power	2	Reference Waveform	83

Related Documentation.....	xv	Area.....	16
Repeating Patterns	25	Names	16
Requirements	2	Parameters.....	127
Restrictions	2	Selecting Measurements	15
Results for Measurements.....	52	Sequence	50
Results Queries for GPIB	147, 148	Modes	50
Variable Names	148	Setting Up	15, 84, 89
Returning to the Application.....	6	Example of Single Waveform Measurement....	84
Rise Time Measurement	18	Example of Two Waveform Measurement.....	89
Algorithm.....	119	Setup Files.....	75, 76, 78, 79
Rising Versus Falling Thresholds.....	42	From Prior Version of Software	78
Rj and Tj Effective Estimation Algorithm.....	114	Recalling Recent	78
Rj/Dj Analysis.....	25, 26	Recalling the Default	78
Arbitrary Patterns	26	Saving	75, 76
Repeating Patterns Using a Spectral Approach	25	Setup Overview.....	11
TDSJIT3 Only	25	Setup Time Measurement	121
Rj/Dj and Equivalent Results.....	53	Algorithm.....	121
Rj/Dj Measurement Algorithm	112	Single Run.....	50, 51
Rj/Dj Separation	104, 112, 114	Mode	50
Application Example	104	New Acq Button	51
Arbitrary Pattern Analysis Based Algorithm..	113	Single Waveform Measurements Algorithms.....	115
Spectrum Analysis Based Algorithm.....	112	Skew Measurement.....	18, 122
Safety Summary.....	xiii	Algorithm.....	122
Sample Rate	111	Smoothing Window and Effect.....	37
See Oscilloscope.....	111	Snapshot of Data Points	95
Saving Data Points.....	73	Software	xix
See Log Measurements.....	73	Source Names and Key for GPIB	149
Saving Measurements	73	Sources and Autosetting.....	38, 49
See Log Measurements.....	73	See Configure Sources Autoset	38
Saving Setup Files	75, 76	Summary of Ref Levels	49
Browser.....	76	Spectrum Analysis	25, 102, 112
Saving Statistics.....	72	Application Example	102
See Log Statistics.....	72	Based Rj/Dj Separation Algorithm	112
Saving Waveforms.....	74	Repeating Patterns	25
See Log Worst Case Waveforms	74	Spectrum Plot.....	54, 105
See Oscilloscope User Manual	74	Definition.....	54
Scroll Bar Definition.....	13	Parameters.....	134
Search Online Help Using the Find Tab.....	xviii	Spectral Analysis Used to Find Jitter Source..	105
Second Monitor.....	55, 64, 101	Usage	56
Select Source.....	16, 127	Spurious Edges and a Hysteresis	43

Spurs	106	Transfer Function Plot	54, 57, 135
Standard Deviation Value Algorithm	123	Definition	54
Start Command Button	51	Parameters.....	135
Starting the Application.....	5	Usage	57
Status Bar Definition	13	Tutorial.....	82, 84, 86, 89, 92, 95, 97
Stop Command Button.....	51	Logging Data Points as a Snapshot.....	95
Straight Line Clock Recovery.....	28	Logging Statistics	92
Sun Java Run-Time Environment.....	2	Logging Worst Case Waveforms	97
Tab Definition.....	13	Measurement Setup.....	84
Table of Contents.....	xviii	Measurement Setup.....	89
Taking Measurements.....	49	Recalling a Waveform File	83
TDSJIT3 v2 Advanced and TDSJIT3 v2 Essentials		Reference Memory Setup	83
Differences	1	Stopping a Lesson	89
TDSJIT3 v2 Application Description	1	Taking a Clock Period Measurement.....	84
TDSJIT3 v2 Directories.....	7	Taking a Clock-to-Output Measurement	89
TDSJIT3 v2 User Interface and Tips	8	Viewing Plots.....	87
Techsupport@tektronix.com.....	xix	Viewing Results.....	86, 89
TekApplications\TDSJIT3v2 Directories	7	Waveform Files	82
Terminology in Online Help Topics	xvii	Two Waveform Measurements Algorithms.....	121
Test Methodology	111	Undocking the Application Window	79
Thresholds and Falling Versus Rising Edges	42	User Interface Conventions.....	13
TIE Measurement	116, 117	User Interface Tips.....	8
Algorithm.....	116, 117	Vertical Autoset of the Sources	38
TIE RjDj Analysis	27, 28, 131	Vertical Cursors in a Plot.....	68, 69
Options	27, 28	Virtual Keypad Definition	13
Parameters	131	Warnings Utility.....	80
Time Trend Plot.....	54, 67, 69, 108, 109	Waveform Edge Configuration	20
Cursors Sync.....	69	Waveform Edges Parameters	128
Definition.....	54	Waveforms	38
Parameters	134	Noise	43
Usage	56	Recalling File to Reference Memory.....	83
Use to Find Jitter Amplitude and Anomalies .	108	Waveforms and Configuration.....	19
Zoom Sync.....	67	Web Sites	xvi
Timing Measurements		Application Updates	xvi
Algorithms.....	112	Wizard.....	11, 12
Tj and Rj Effective Estimation Algorithm.....	114	Worst Case Waveforms	74, 75
Tj Estimation and BER Algorithm	114	See Log Worst Case Waveforms	74
TOC	xviii	Zoom	66, 67
Toolbar Functions in Plot Windows	64	In 66	
Transfer Function Definition	61, 62	Out	67
Menu.....	62		
TDSJIT3 v2 Jitter Analysis Online Help			

Sync	67	Zoom Gating	40, 41
Using in Plots.....	66	Definition.....	41